

EN | VALID FROM 01.03.2023 - 31.12.2023

GEDORE  red

IMPULSE ²³

TOOL PROMOTION

€1536,⁹⁷
+ MwSt.

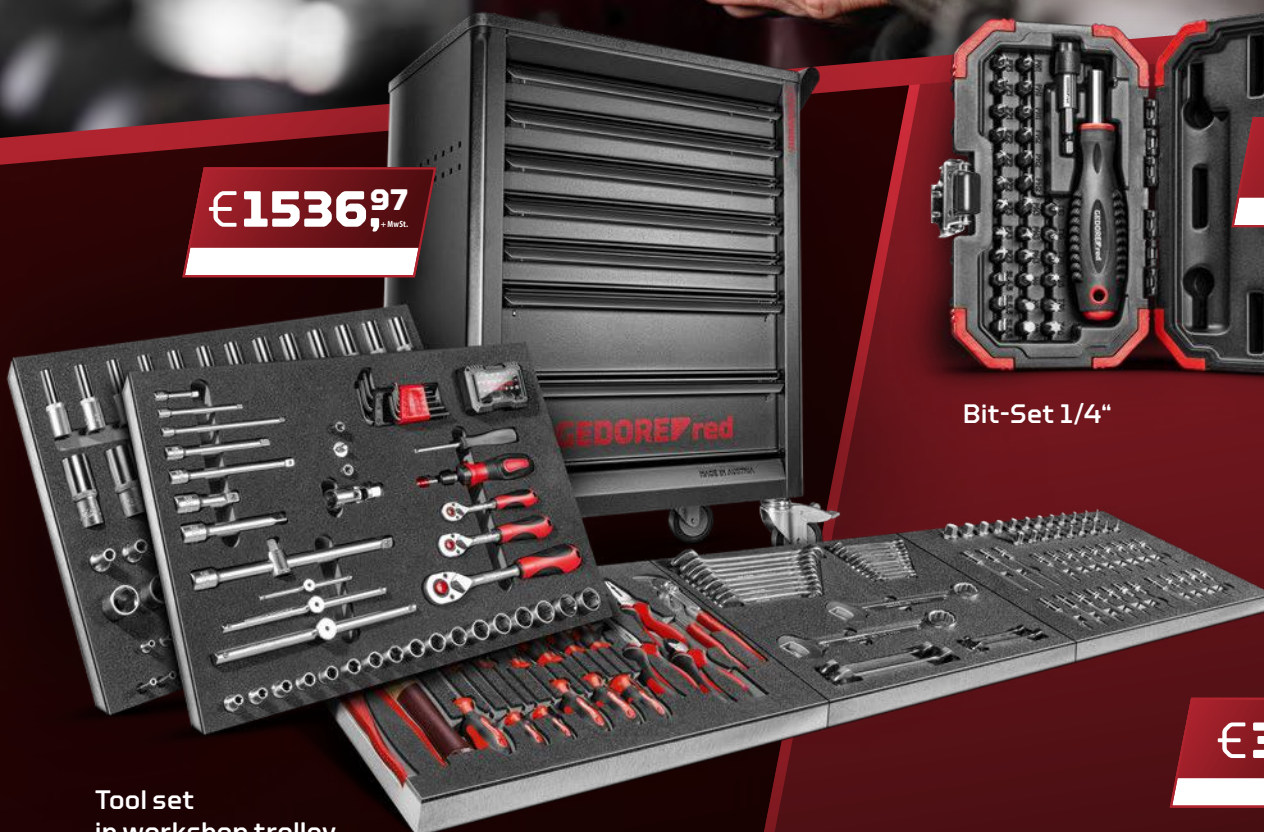

Tool set
in workshop trolley
GEDMaster



€26,²¹
+ MwSt.

Bit-Set 1/4"

€36,¹³
+ MwSt.

Inspection lamp



HIGHLIGHTS

2023

R2818 4010
PLIER
WRENCH
48



R3300 3040
BIT SET 1/4"
10



R2207 1005
TOOL SET IN
WORKSHOP
TROLLEY
GEDMASTER
44



















R9560 0320
INSPECTION
LAMP

58



CONTENTS

| | | |
|---|------------------------------------|-------------------------|
|  | RATCHET SPANNERS | 04 – 07 |
|  | SOCKET SETS | 08 – 25, 30 |
|  | BIKE-SETS | 26 – 29 |
|  | AUTOMOTIVE | 31 |
|  | RANGE OF SOCKETS | 32 – 34 |
|  | TORQUE WRENCHES | 34 |
|  | SCREWDRIVERS AND BITS | 16 – 17, 35 – 37 |
|  | WORKSHOP EQUIPMENT | 38 – 45 |
|  | STRIKING TOOLS | 46 |
|  | PLIERS | 48 – 49 |
|  | 1000V | 50 – 52 |
|  | WORK LAMPS | 53 – 61 |
|  | CUTTING / FILING / DRILLING | 62, 64 – 65 |
|  | MEASURING / MARKING | 63 |

R0910 XXXX
COMBINATION
SPANNER SET
metric



- > Acc. to DIN 3113, Form A, ISO 3318, ISO 7738
- > Jaw set at 15°
- > In holder

from

€35,20
+ VAT



| Code | No. | Contents | Length mm | Width mm | Height mm | Pieces | Weight kg | excl. VAT |
|---------|-----------|--|-----------|----------|-----------|--------|-----------|-----------|
| 3300989 | R09105010 | 8 10 11 12 13 14 15 17 19 22 mm | 265 | 185 | 46 | 10 | 1.366 | 35,20 |
| 3300993 | R09105015 | 6 7 8 10 11 12 13 14 17 19 22 24 27 30 32 mm | 365 | 275 | 70 | 15 | 3.1 | 66,46 |

R0510 5012
DOUBLE
OPEN ENDED
SPANNER SET
long, metric, 12 pieces



- > Acc. to DIN 3110, ISO 3318, ISO 1085, ISO 10102
- > Jaw set at 15°
- > In holder

€40,83
+ VAT



| Code | No. | Contents | Length mm | Width mm | Height mm | Pieces | Weight kg |
|---------|-----------|---|-----------|----------|-----------|--------|-----------|
| 3300960 | R05105012 | Double open-end wrench 6x7 8x9 10x11 12x13 14x15 16x17 18x19 20x22 21x23 24x27 25x28 30x32 mm | 300 | 180 | 66 | 12 | 2.42 |

R0512 6008
DOUBLE OPEN ENDED
SPANNER SET
in wallet, metric, 8 pieces



- > Acc. to DIN 895, ISO 3318, ISO 1085
- > Jaw set at 15°
- > In practical roll-wallet

€23,77
+ VAT



| Code | No. | Contents | Length mm | Width mm | Height mm | Pieces | Weight kg |
|---------|-----------|--|-----------|----------|-----------|--------|-----------|
| 3301081 | R05126008 | 6x7 8x9 10x11 12x13 14x15 16x17 18x19 20x22 mm | 235 | 60 | 60 | 8 | 0.64 |

R0720 5005
COMBINATION RATCHET
SPANNER SET
 reversible, 5 pieces

€61,76
 + VAT



- > In accordance with DIN 3113, ISO 3318
- > Ring offset to 15°, reversible for right and left hand operation
- > 72 teeth Ratchet mechanism
- > In holder



| Code | No. | Contents | Length mm | Width mm | Height mm | Pieces | Weight kg |
|---------|-----------|------------------|-----------|----------|-----------|--------|-----------|
| 3300872 | R07205005 | 8 10 13 17 19 mm | 245 | 180 | 35 | 5 | 0.688 |

R0710 5012
COMBINATION RATCHET
SPANNER SET
 metric, 12 pieces

€112,61
 + VAT



- > In accordance with DIN 3113, ISO 3318
- > Straight pattern
- > 72 teeth Ratchet mechanism
- > In holder



| Code | No. | Contents | Length mm | Width mm | Height mm | Pieces | Weight kg |
|---------|-----------|--------------------------------------|-----------|----------|-----------|--------|-----------|
| 3300850 | R07105012 | 8 9 10 11 12 13 14 15 16 17 18 19 mm | 320 | 250 | 41 | 12 | 1.569 |



R0740 5006
DOUBLE RING RATCHET
SPANNER SET
 straight, metric, 6 pieces

€94,12
 + VAT



- > In accordance with DIN 837
- > Straight pattern
- > 72 teeth Ratchet mechanism
- > In holder

| Code | No. | Contents |
|---------|-----------|--------------------------------------|
| 3300898 | R07405006 | 8x9 10x11 12x13 14x15 16x18 17x19 mm |

| Pieces | Weight kg |
|--------|-----------|
| 6 | 0.865 |

R0750 1019
DOUBLE RING RATCHET SPANNER
 4in1

€31,34
 + VAT



- > The four most common wrench sizes, covered by just one tool
- > Straight pattern
- > With lever change

| Code | No. | Width across flats mm | Length mm |
|---------|-----------|-----------------------|-----------|
| 3300899 | R07501019 | 10 x 13 x 17 x 19 | 210 |

| Weight kg |
|-----------|
| 0.21 |



R0590 5004
COMBINATION RATCHET
SPANNER SET
 metric, 4 pieces

€28,48
 + VAT



- > In accordance with DIN 3113, ISO 3318
- > Open end with ratchet function
- > Jaw set at 15°
- > Ring side open, offset to 15°
- > Matt satin chrome-plated finish
- > Chrome-vanadium steel
- > In holder

| Code | No. | Contents |
|---------|-----------|----------------|
| 3300032 | R05905004 | 10 13 17 19 mm |

| Pieces | Weight kg |
|--------|-----------|
| 4 | 0.7 |

WELL EQUIPPED ON THE GO

The 1/4" bit set R33003032 is perfect for the smallest screwdriving jobs in mobile use.

The 32-piece **GEDORE red bit set R33003032** includes an extensive selection of bits for the smallest screw connections in the 1/4" range. The screwdriver with its strong magnet is used to securely fix the bits and enables quick and easy bit replacement.

The quick-change adapter also enables use with a cordless Power tool. The set is safely stored in our robust case from **GEDORE red**. With its wide range of possible uses and practical storage, it is the perfect companion for on the go applications.



Bit set 1/4" R33003032

1

FAST BIT CHANGE

- The quick-change adapter makes changing bits very smooth. In addition, it is suitable for both manual and machine-operated work

2

SECURE STORAGE

- The tools are safely stored in a robust carrying case. Due to its low weight and its handiness, it is ideal for mobile use

3

COMFORTABLE WORKING

- The ergonomic handle of the screwdriver ensures fatigue-free work. The bits are prevented from falling out by the magnetic bit screwdriver and ensure relaxed work



SMALL ALL-ROUNDER

"With the 32-piece bit set, you are optimally equipped to work on all kinds of small screw connections when you are on the move."



NEW

R3300 3032
BIT SET 1/4"
 32 pieces

€26,²¹
 + VAT



- > Screwdriver with strong magnet for quick and easy bit replacement and ergonomic grip
- > Quick-change adapter enables quick bit changes
- > Suitable for hand and machine operated work
- > Storage in robust BMC



| Code | No. | Contents | Width mm | Height mm | Depth mm | Pieces | Weight kg |
|---------|-----------|---|----------|-----------|----------|--------|-----------|
| 3301348 | R33003032 | 1/4" Magnetic Bit Screwdriver 1/4" quick change adapter 1/4" bits, 25mm: PH1 (3x), PH2 (3x), PH3 (3x) PZ1 (3x), PZ2 (3x), PZ3 (3x) Slot 4.5 5.5 6.5 TX T10 T15 T20 T25 T30 T40 Inside hexagon 4 5 6 mm | 190 | 52 | 110 | 32 | 0,48 |

THE ALTERNATIVE FOR CRAMPED FASTENER SITUATIONS

With the included ratchet, the 40-piece bit set offers the ideal solution when things need to be done quickly or there is not enough space for the screwdriver.

The 40-piece **GEDORE red bit set R33003040** includes an extensive selection of bits and sockets for a variety of screw applications in the 1/4" area. The included bit screwdriver with its strong magnet is used to securely fix the bits and enables quick and easy bit replacement. If there is not enough space or the tightening has to be done more quickly, the high-quality reversible ratchet with its small return angle of 5° shows its strengths. The included bit adapter enables bits to be used in conjunction with the reversible ratchet and thus provides a smart alternative in use. The quick-change adapter also enables use with a cordless Power tools. Safely housed in the robust transport case from **GEDORE red**, everything is easily stored away and ideal for mobile use.



Bit set 1/4" R33003040

1

SMART ALTERNATIVE

- The bit adapter enables the bits to be driven with the reversible ratchet

2

COMFORTABLE WORKING

- The ergonomic handle of the screwdriver ensures fatigue-free work. The bits are prevented from falling out by the magnetic bit screwdriver and thus ensure relaxed work.

3

PRECISE IN USE

- The high-quality, fine-toothed lever reversible ratchet with a 5° return angle ensures precise and smooth screw tightening



**SMART
SOLUTION**

"Thanks to the well-assorted selection and the ratchet as an alternative, you are always well served on the go and in the workshop with the 40-piece bit set."

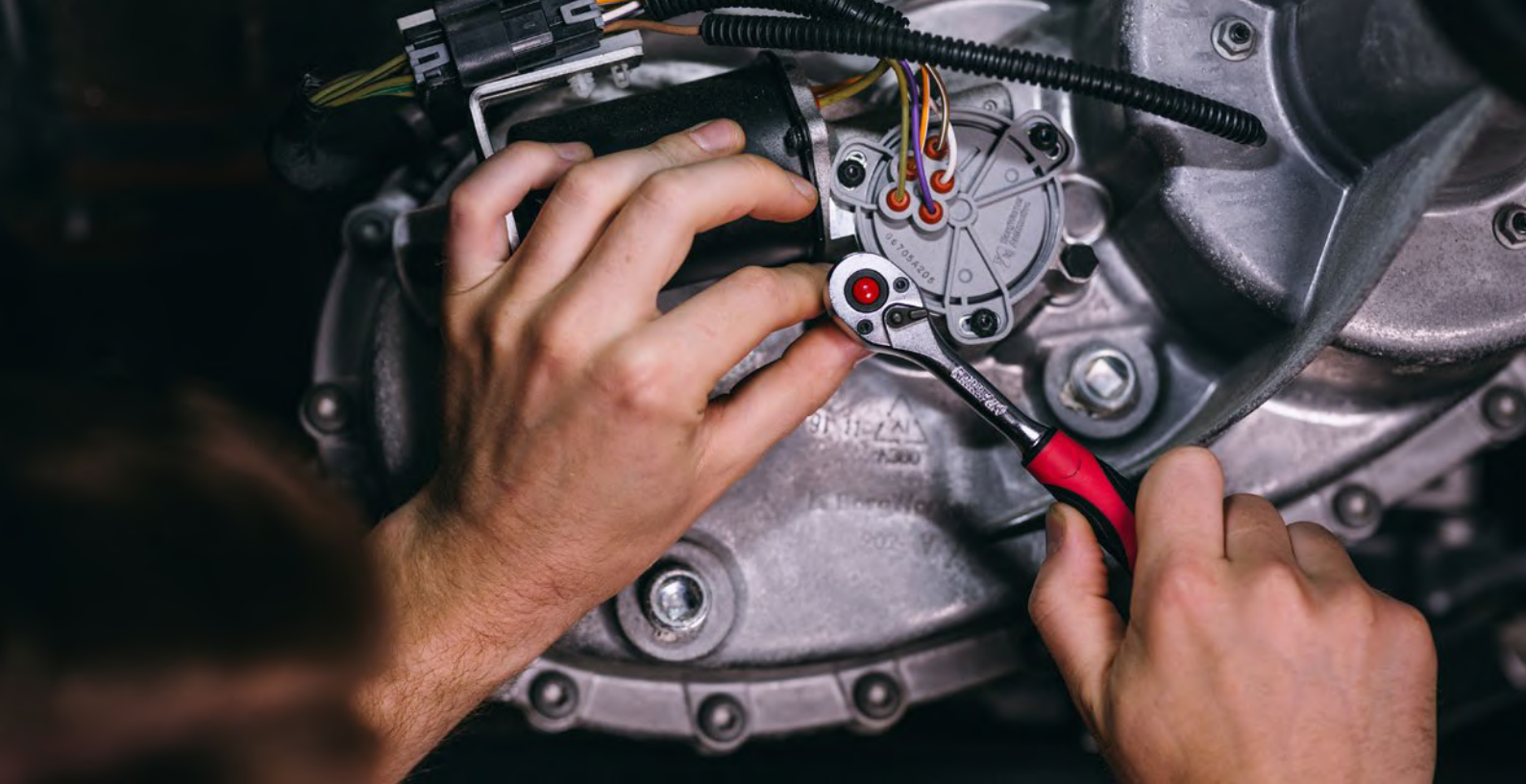

NEW

R3300 3040
BIT SET 1/4"
 40 pieces



- › Screwdriver with strong magnet for quick and easy bit replacement and ergonomic grip
- › Reversible ratchet with 2C handle and 5° return angle as well as switch lever for easy change of direction
- › Bit adapter enables alternative drive of the bits with the reversible ratchet
- › Quick-change adapter enables quick bit changes
- › Sockets with non-slip longitudinal knurling
- › Storage in robust BMC

€40,66
 + VAT



| Code | No. | Contents | Width mm | Height mm | Depth mm | Pieces | Weight kg |
|----------------|-----------|---|----------|-----------|----------|--------|-----------|
| 3301349 | R33003040 | 1/4" sockets 5.5 6 7 8 10 12 13 mm 1/4" reversible ratchet 1/4" adapter 4kt x 6kt 1/4" magnetic bit screwdriver 1/4" quick change adapter 1/4" bits, 25mm: PH1 (2x), PH2 (3x), PH3 (1x) PZ1 (1x), PZ2 (3x), PZ3 (1x) Slot 5.5mm Inside hexagon 3 4 5 6 8 mm TX T10 T15 T20 T25 T30 T40 TX T10H T15H T20H T25H T30H Bit adapter 1/4" square x 1/4" hex | 230 | 52 | 130 | 40 | 0,8 |

CAN'T BE BEATEN IN LENGTH

With the practical 1/4" bit set, even low-lying screw applications are no longer a problem.

The 51-piece bit set **R33003051** from **GEDORE red** is particularly suitable for hard-to-reach screw connections thanks to the long bits and its extension. In connection with the lever reversible ratchet, even deep-lying screw jobs can be loosened or tightened in no time at all. The high-quality reversible ratchet with its return swivel angle of 5° is the ideal drive, even when things get a little tight. The included bit adapter enables bits to be used in conjunction with the reversible ratchet and thus provides a smart alternative in use. Safely housed in the robust transport case from **GEDORE red**, everything is well stowed away and also ready for mobile use.



Bit set 1/4" R33003051

1

PRECISE IN USE

- The high-quality, fine-toothed lever reversible ratchet with a 5° return angle ensures precise and smooth screw tightening

2

SOLUTION FOR DEEP-SET SCREWS

- Thanks to the long bits and the extension, deep-seated screws are also easy to reach

3

SMART ALTERNATIVE

- The bit adapter enables the bits to be driven with the reversible ratchet



IN-DEPTH PROBLEM SOLVING

"The 51-piece bit set also solves deep-seated screwdriving problems."

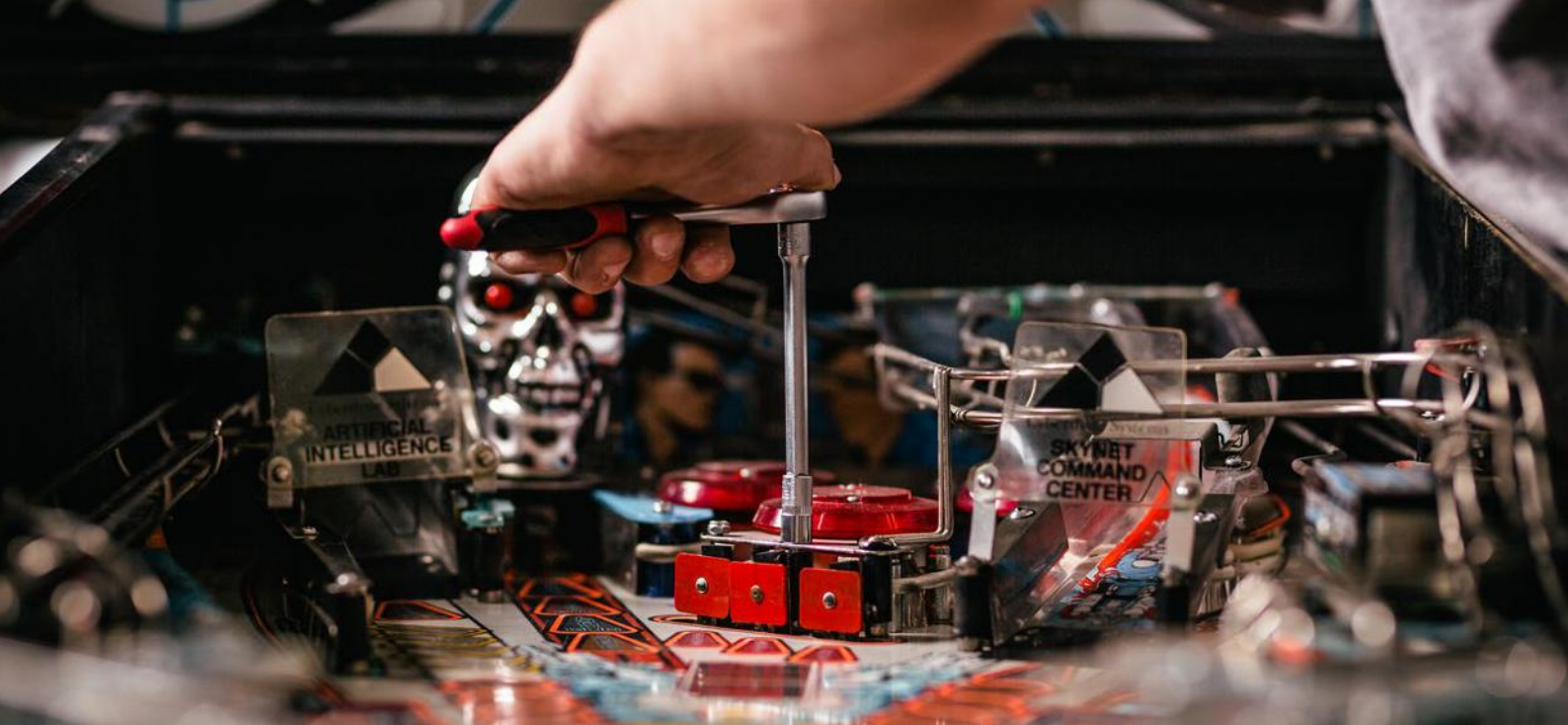

NEW

R3300 3051
BIT SET 1/4"
 51 pieces

- > Long bits
- > Reversible ratchet with 2C handle and 5° return angle as well as switch lever for easy change of direction
- > Bit adapter enables alternative drive of the bits with the reversible ratchet
- > Sockets with non-slip longitudinal knurling
- > Storage in robust BMC



€ 42,51
 + VAT



| Code | No. | Contents | Width mm | Height mm | Depth mm | Pieces | Weight kg |
|----------------|-----------|---|----------|-----------|----------|--------|-----------|
| 3301350 | R33003051 | 1/4" sockets 4 5 5.5 6 7 8 9 10 11 12 13 14 mm 1/4" reversible ratchet 1/4" extension 100mm 1/4" adapter 4kt x 6kt 1/4" bits 25mm: PH1 (1x), PH2 (2x), PH3 (1x) PZ1 (1x), PZ2 (2x), PZ3 (1x) Slot 4 4.5 6.5mm TX T10 T15 T20 T25 T27 T30 T40 Inside hexagon 2 3 4 5 6 mm Bit adapter 1/4" square x 1/4" hex 1/4" bits 90mm: PH1 (1x), PH2 (1x) PH1 (1x), PH2 (1x) TX T20 T25 T30 Inside hexagon 3 4 5 6 mm Slot 5.5mm | 230 | 52 | 130 | 51 | 0,98 |

THE VERSATILE

With its variety of tools, the 1/4" bit set is optimally designed for work in the smallest of spaces.

The 67-piece **GEDORE red bit set R33003067** is set up for any screw connections in the 1/4" area thanks to its versatile contents. Even deep-set screws are no longer a problem thanks to the long bits. The bit screwdriver with its ergonomic handle and a strong magnet to fix the bits replaces a large number of screwdrivers. The offset screwdrivers are a practical supplement in use. The quick-change adapter also enables use with a cordless screwdriver. Safely housed in the robust transport case from **GEDORE red**, everything is well stowed away and also ready for mobile use.



Bit set 1/4" R33003067

1 FAST BIT CHANGE

- The quick-change adapter makes changing bits child's play. In addition, it is suitable for both manual and machine-operated work

2 COMFORTABLE WORKING

- The ergonomic handle of the screwdriver ensures fatigue-free work. The bits are prevented from falling out by the magnetic bit screwdriver and thus ensure relaxed work

3 SOLUTION FOR DEEP-SET SCREWS

- Thanks to the long bits and the extension, deep-seated screws are also easy to reach



"With its variety, the 67-piece bit set is a good choice for a wide range of applications and a top alternative to the screwdriver set."



NEW

R3300 3067
BIT SET 1/4"
 67 pieces

- > Long bits
- > Screwdriver with strong magnet for quick and easy bit replacement and ergonomic grip
- > Quick-change adapter enables quick bit changes
- > Storage in robust BMC

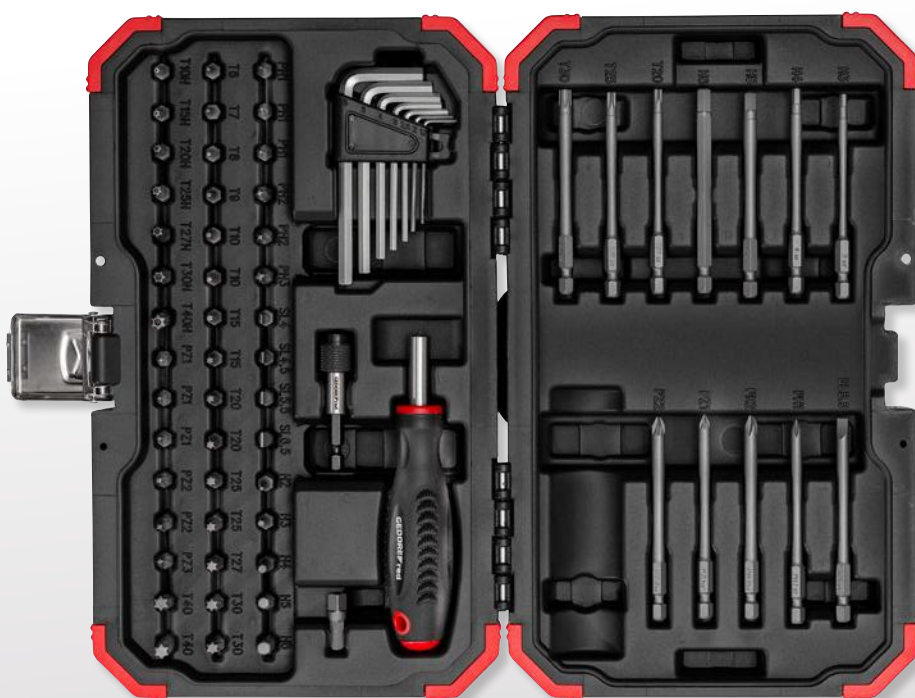

€42,51
 + VAT



| Code | No. | Contents | Width mm | Height mm | Depth mm | Pieces | Weight kg |
|----------------|-----------|--|----------|-----------|----------|--------|-----------|
| 3301352 | R33003067 | Offset screwdriver set 1.5, 2, 2.5, 3, 4, 5, 6 mm 1/4" magnetic bit screwdriver 1/4" quick change adapter 1/4" bits, 25mm: PH1 (3x), PH2 (2x), PH3 (1x) PZ1 (3x), PZ2 (2x), PZ3 (1x) Slot 4, 4.5, 5.5, 6.5mm TX T6, T7, T8, T9, T10, T10, T15, T15, T20, T20, T25, T25, T27, T30, T30, T40, T40 TX T10H, T15H, T20H, T25H, T27H, T30H, T40H Inside hexagon 2, 3, 4, 5, 6 mm Bit adapter 1/4" square x 1/4" hex 1/4" bits, 90mm: PH1 (1x), PH2 (1x) PZ1 (1x), PZ2 (1x) TX T20, T25, T30 Inside hexagon 3, 4, 5, 6 mm Slot 5.5mm | 300 | 52 | 180 | 67 | 1,1 |

R3300 5014
BIT BOX 1/4"

14 pieces

€9,49
+ VAT



- > Bit box with the common bit sizes and drive adaptor with bit locking
- > Hexagon drive acc. to DIN 3126 ISO 1173 - C 6.3
- > Machine-operated



| Code | No. | Contents | Width mm | Height mm | Depth mm | Pieces | Weight kg |
|---------|-----------|---|----------|-----------|----------|--------|-----------|
| 3301347 | R33005014 | 1/4" hexagon 3 4 5 mm 1/4" slot 4 5 6 mm 1/4" cross recess PH 1 2 3 1/4" TX T10 T15 T20 T25 Bit holder 1/4" hex x 1/4" hex, with magnet | 105 | 30 | 60 | 14 | 0.1 |

R3300 5007
BIT BOX 1/4"

7 pieces

€6,71
+ VAT



- > Bit box with the common bit sizes and drive adaptor with bit locking
- > Hexagon drive acc. to DIN 3126 ISO 1173 - C 6.3
- > Machine-operated



| Code | No. | Contents | Width mm | Height mm | Depth mm | Pieces | Weight kg |
|---------|-----------|---|----------|-----------|----------|--------|-----------|
| 3301345 | R33005007 | 1/4" slot 4 5 6 mm 1/4" cross recess PH 1 2 3 Bit holder 1/4" hex x 1/4" hex, with magnet | 105 | 30 | 60 | 7 | 0.08 |

R3300 5009
BIT BOX 1/4"

9 pieces

€7,64
+ VAT



- > Bit box with the common bit sizes and drive adaptor with bit locking
- > Hexagon drive acc. to DIN 3126 ISO 1173 - C 6.3
- > Machine-operated



| Code | No. | Contents | Width mm | Height mm | Depth mm | Pieces | Weight kg |
|---------|-----------|---|----------|-----------|----------|--------|-----------|
| 3301346 | R33005009 | 1/4" internal hexagon SW 3 4 5 mm 1/4" Slot 4 5 6 mm 1/4" PH 1 2 Bit holder 1/4" hex x 1/4" hex, with magnet | 105 | 30 | 60 | 9 | 0.086 |

R3500 3040
BIT SET TX /
XZN / SK
 40 pieces

€37,97
 + VAT



- > Reinforced bits, 10 mm
- > Hand-operated
- > Hexagon drive acc. to DIN 3126 ISO 1173 - C 10
- > In rugged plastic case



| Code | No. | Contents | Width mm | Height mm | Depth mm | Pieces | Weight kg |
|---------|-----------|--|----------|-----------|----------|--------|-----------|
| 3301572 | R35003040 | Internal hexagon bit 4 5 6 8 10 12 30 mm, Internal hexagon bit 4 5 6 8 10 12 75 mm TX bit T20 T25 T30 T40 T45 T50 T55 30 mm, TX bit T20 T25 T30 T40 T45 T50 T55 75 mm XZN bit M5 M6 M8 M10 M12 30 mm, XZN bit M5 M6 M8 M10 M12 75 mm Bit adapter inside square drive 1/2" on inside hexagon socket 10mm Bit adapter inside square drive 3/8" on inside hexagon socket 10mm | 335 | 50 | 195 | 40 | 1.75 |

R3300 5031
BIT BOX 1/4"
 32 pieces

€14,28
 + VAT



- > Bits: Hardness: 60 HRC +/- 2, torque: 18.4 Nm
- > Drive adaptor with magnetic bit locking
- > Hexagon drive acc. to DIN 3126 ISO 1173 - C 6.3
- > Machine-operated
- > Box with clear cover



| Code | No. | Contents | Width mm | Height mm | Depth mm | Pieces | Weight kg |
|---------|-----------|---|----------|-----------|----------|--------|-----------|
| 3301338 | R33005031 | 1/4" hexagon 3 4 5, 1/4" slotted 0.6x4.5 1.0x5.5 1.2x6.5 2x 1/4" cross-head PH 1 2 3, 2x 1/4" cross-head PZ 1 2 3 2x TX T10 T15 T20 T25 T30 T40, Quick change adaptor for 1/4" bits C 6.3 with magnet Bit adaptor 1/4" hex x 1/4" square | 110 | 40 | 70 | 32 | 0.25 |

R4900 3046
SOCKET
SET 1/4"
 46 pieces

€47,47
 + VAT

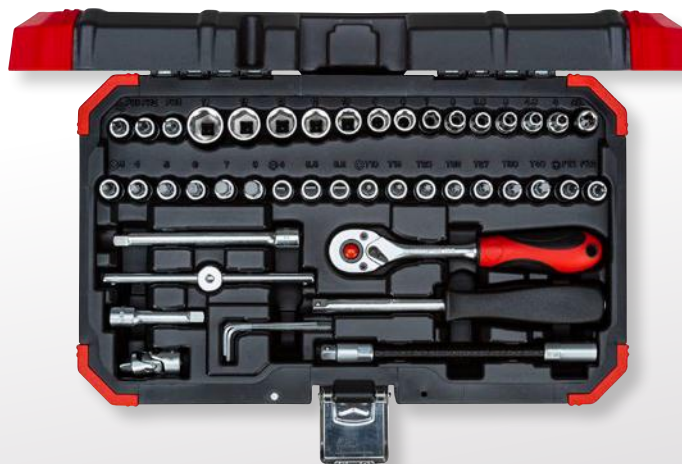

- > For hand-operated applications
- > Plastic case in GEDORE red Design



| Code | No. | Contents | Width mm | Height mm | Depth mm | Pieces | Weight kg |
|---------|-----------|---|----------|-----------|----------|--------|-----------|
| 3300052 | R49003046 | 1/4" 2C reversible lever ratchet fine-toothed, 72 teeth 150 mm 1/4" square socket 165 mm, 1/4" socket hexagon 4 4.5 5 5.5 6 7 8 9 10 11 12 13 14 25 mm 1/4" screwdriver bit socket hexagon socket inner 3 4 5 6 7 8 37 mm 1/4" screwdriver bit socket slot 4 5 5.5 6.5 37 mm 1/4" Screwdriver bit socket Phillips PH 1 2 3 37 mm 1/4" Screwdriver bit socket Phillips PZ 1 2 37 mm 1/4" Screwdriver bit socket TX T10 T15 T20 T25 T27 T30 T40 37 mm 1/4" Socket wrench extension 50 100 mm, 1/4" Flexible socket wrench extension 150 mm 1/4" Cross handle with slide 115 mm, 1/4" Cardan joint 32 mm Bit-Adapter 1/4" square x 1/4" hexagon 25 mm Allen wrench set hexagon 1.27 1.5 2 2.5 mm | 298 | 54 | 185 | 46 | 1.414 |

R5900 3026
SOCKET
SET 3/8"
 26 pieces

€60,75
 + VAT



- > For hand-operated applications
- > Plastic case in GEDORE red Design



| Code | No. | Contents | Width mm | Height mm | Depth mm | Pieces | Weight kg |
|---------|-----------|---|----------|-----------|----------|--------|-----------|
| 3300053 | R59003026 | 3/8" 2C lever reversible ratchet fine-toothed, 72 teeth 180 mm 3/8" socket wrench insert bi-hex 6 7 8 9 10 11 12 13 14 15 16 17 18 19 20 21 22 24 mm 3/8" spark plug insert 16 21 mm 65 mm 3/8" socket wrench extension 75 150 mm, 3/8" cross handle with sliding piece 200 mm 3/8" Cardan joint 48 mm, Reducer 3/8" - 1/4" 27 mm | 302 | 54 | 185 | 26 | 2.44 |

R6900 3069
SOCKET WRENCH SET 1/2"
SERVICE
 69 pieces

€178,99
 + VAT

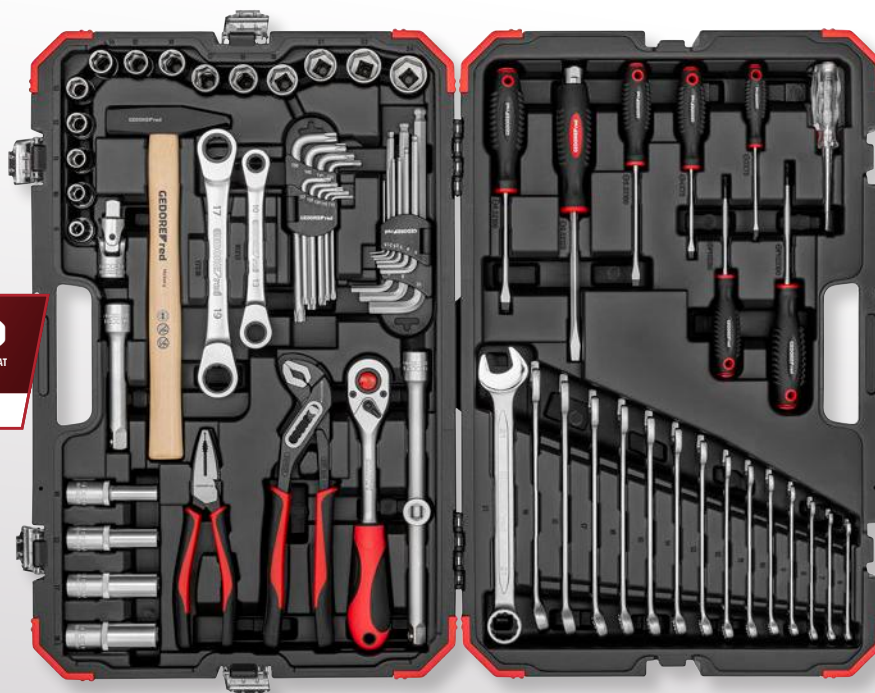

- > For hand-operated applications
- > Plastic case in GEDORE red Design



| Code | No. | Contents | Width mm | Height mm | Depth mm | Pieces | Weight kg |
|---------|-----------|--|----------|-----------|----------|--------|-----------|
| 3300191 | R69003069 | 1/2" 2K lever reversible ratchet, fine-toothed, 72 teeth 250 mm 1/2" socket wrench insert hexagon SW 10 11 12 13 14 15 16 17 18 19 21 22 24 38 mm 1/2" socket wrench insert hexagon SW 10 13 17 19 77mm 1/2" socket wrench extension 125 250 mm, 1/2" universal joint 66 mm Enlargement piece 3/8 x 1/2 square 44mm Double ring ratchet wrench SW 10x13 17x19 Combination wrench SW 6 7 8 9 10 11 12 13 14 15 16 17 18 19 21 Allen key set, hexagon socket SW 1.5 2.2 5 3 4 5 6 8 10 Offset screwdriver set TX T10 T15 T20 T25 T27 T30 T40 T45 T50 Slotted screwdriver 3 4 5.5 6.5, Slotted screwdriver with impact cap 6.5 Screwdriver Phillips PH 1 2, Phase tester slot 120-250 V Combination pliers 180 mm, Water pump pliers 10", Machinist's hammer 300 g | 552 | 100 | 360 | 69 | 9.9 |

R6900 3061
SOCKET WRENCH SET 1/2"
AUTO-UNIVERSAL
 61 pieces

- > For hand-operated applications
- > Plastic case in GEDORE red Design



| Code | No. | Contents | Width mm | Height mm | Depth mm | Pieces | Weight kg |
|---------|-----------|--|----------|-----------|----------|--------|-----------|
| 3300370 | R69003061 | R6100xxxx Socket 1/2" hexagon 8 9 10 11 12 13 14 15 16 17 19 21 22 24 mm R60000027 2K reversible ratchet 1/2" L. 250 mm RSW 5° R65300012 Universal joint 1/2" L. 66 mm R6102xxxx Spark plug socket 1/2" 16 18 21 mm R651000xx Socket extension 1/2" L. 125 250 mm R57300008 Extension piece 3/8" x 1/2 square L.44 mm R28100010 Water pump pliers 10" 7-fold R28302180 Combination pliers L. 180 mm 2K handle R36605008 Hex key set 1.5-8 mm 8 pcs. R36405008 Offset screwdriver set TX T9-40 8 pcs. R92100020 Machinist's hammer 500 g L. 320 mm ash R0910xxxx combination wrenches 6 7 8 9 10 11 12 13 14 15 16 17 18 19 mm R38100315 2K screwdriver slotted 3 mm 0.5x75 mm, 5.5 mm 1x100 mm, 8 mm 1.2x100 mm R38200115 2K screwdriver PH1 L. 80 mm, PH2 L. 100 mm R38120001 MOTOR VEHICLE voltage tester 3-48 V | 452 | 86 | 340 | 61 | 7.14 |

R6100 3114
SOCKET SET 1/2"
 long, 14 pieces

- > For hand-operated applications
- > Plastic case in GEDORE red Design



| Code | No. | Contents | Width mm | Height mm | Depth mm | Pieces | Weight kg |
|---------|-----------|---|----------|-----------|----------|--------|-----------|
| 3300008 | R61003114 | 10 12 13 14 15 17 19 21 22 23 24 27 30 32 77 mm | 272 | 80 | 383 | 14 | 3.746 |

R6800 3016
SOCKET SET 1/2" TX
 16 pieces

- › For hand-operated screw work
- › Plastic case in GEDORE red Design

€56,97
 + VAT



| Code | No. | Contents | Width mm | Height mm | Depth mm | Pieces | Weight kg |
|---------|-----------|--|----------|-----------|----------|--------|-----------|
| 3300009 | R68003016 | Socket wrench insert TX E10 E11 E12 E14 E16 E18 E20 E22 E24 Screwdriver bit socket TX T30 T40 T45 T50 T55 T60 T70 | 300 | 52 | 180 | 16 | 1.69 |

R6800 3020
SOCKET SET 3/8" + 1/2"
 20 pieces

- › For hand-operated applications
- › Plastic case in GEDORE red Design

€56,97
 + VAT



| Code | No. | Contents | Width mm | Height mm | Depth mm | Pieces | Weight kg |
|---------|-----------|--|----------|-----------|----------|--------|-----------|
| 3300045 | R68003020 | 3/8" socket wrench insert TX E6 E7 E8 E10 3/8" screwdriver bit socket TX T10 T15 T20 T25 T27 1/2" socket wrench insert TX E12 E14 E16 E18 E20 1/2" screwdriver bit socket TX T30 T40 T45 T50 T55 Reducer 1/2" square x 3/8" square | 180 | 52 | 300 | 20 | 2 |

R6901 3024
SOCKET
SET 1/2"
 bi-hex, 24 pieces



- > For hand-operated screw work
- > Plastic case in GEDORE red Design

€66,46
 + VAT



| Code | No. | Contents | Width mm | Height mm | Depth mm | Pieces | Weight kg |
|---------|-----------|--|----------|-----------|----------|--------|-----------|
| 3300056 | R69013024 | 1/2" 2C Lever reversible ratchet fine toothed, 72 teeth 250 mm 1/2" Socket wrench insert 12-point SW 10 11 12 13 14 15 16 17 18 19 20 21 22 23 24 26 27 28 30 32 1/2" Socket wrench extension 125 250 mm Enlarging/sliding piece 3/8" x 1/2" 44 mm | 385 | 84 | 280 | 24 | 4.75 |

R6304 3003
IMPACT SOCKET
SET 1/2"
 3 pieces



- > Specially for fitting / removing wheels of vehicles
- > Plastic sleeves
- > Square drive as per DIN 3121 - G 12,5, ISO 1174
- > Acc. to DIN 3129, ISO 2725-2
- > Machine-operated, fixing with safety ring / pin
- > In rugged plastic case

€28,48
 + VAT



| Code | No. | Contents | Width mm | Height mm | Depth mm | Pieces | Weight kg |
|---------|-----------|--|----------|-----------|----------|--------|-----------|
| 3300578 | R63043003 | Impact screwdriver socket 17 19 21 mm 86mm | 155 | 52 | 135 | 3 | 0.83 |

R6300 3012
IMPACT WRENCH
SOCKET SET 1/2"
 12 pieces



- > Square drive as per DIN 3121 - G 12,5, ISO 1174
- > Acc. to DIN 3129, ISO 2725-2
- > Machine-operated, fixing with safety ring / pin
- > Plastic case in GEDORE red Design

€52,26
 + VAT



| Code | No. | Contents | Width mm | Height mm | Depth mm | Pieces | Weight kg |
|---------|-----------|--|----------|-----------|----------|--------|-----------|
| 3300574 | R63003012 | 10 11 12 13 14 15 16 17 19 21 22 24 mm | 180 | 52 | 185 | 12 | 1.598 |

R7800 4014
SOCKET SET 3/4"
 14 pieces

€244,54
 + VAT



- > For hand-operated applications
- > Plastic case in GEDORE red Design



| Code | No. | Contents | Width mm | Height mm | Depth mm | Pieces | Weight kg |
|---------|-----------|--|----------|-----------|----------|--------|-----------|
| 3300011 | R78004014 | 3/4" Reversible ratchet, coarse toothing, 24 teeth 510 mm 3/4" Hexagon socket wrench insert 22 24 27 30 32 36 38 41 46 50 mm 3/4" Socket wrench extensions 200 400 mm 3/4" Cross handle with sliding piece 460 mm | 548 | 105 | 105 | 14 | 14.2 |

R4600 3092
SOCKET SET
1/4" + 1/2"
 92 pieces

€103,36
 + VAT

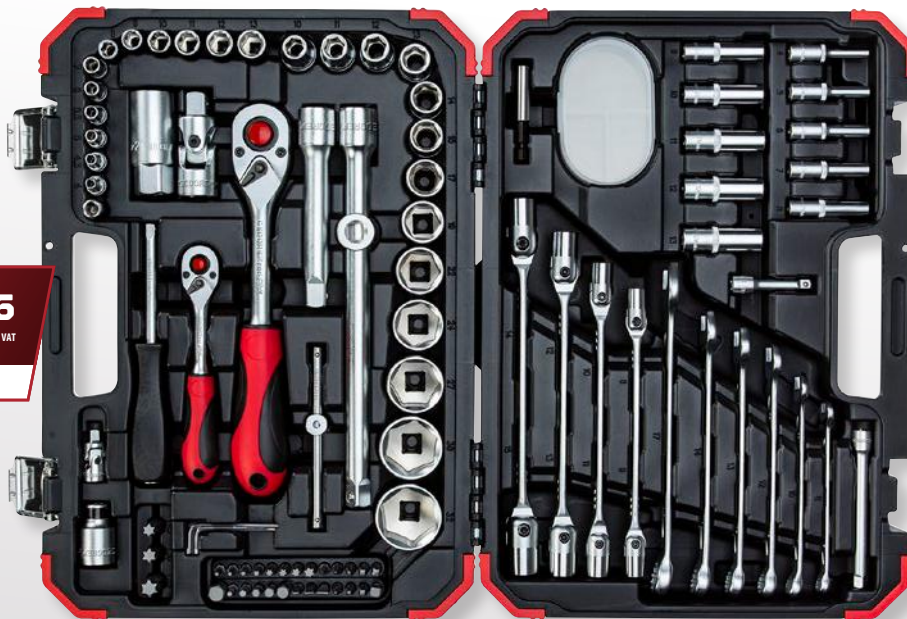

- > For hand-operated applications
- > Plastic case in GEDORE red Design



| Code | No. | Contents | Width mm | Height mm | Depth mm | Pieces | Weight kg |
|---------|-----------|---|----------|-----------|----------|--------|-----------|
| 3300062 | R46003092 | 1/4" 2C lever reversible ratchet fine-toothed, 72 teeth 150 mm 1/4" square plug-in handle 165 mm 1/4" socket wrench insert hexagon 4 4.5 5 5.5 6 7 8 9 10 11 12 13 mm 1/4" socket wrench insert hexagon 4 5 6 7 8 9 10 11 12 13 mm 50 mm 1/4" socket wrench extension 50 100 mm 1/4" cross handle with sliding piece 115 mm, 1/4" universal joint 32 mm Bit holder 1/4" hexagonal x 1/4" hexagonal, with magnet 60 mm Bit adaptor 1/4" square x 1/4" hexagon 25 mm Drive adaptor 1/4" hexagon x square with ball lock 25 mm 1/4" bits inner hexagon 3 4 5 6 8 10 25 mm, 1/4" bits slot 4 5 5 7 25 mm 1/4" bits cross recess PH 0 1 2 3 4 25 mm, 1/4" bits cross recess PZ 1 2 3 25 mm 1/4" bits TX T8 T10 T15 T20 T25 T27 T30 T40 25 mm, 5/16" bits TX T45 T50 T55 30 mm 1/2" 2C lever reversible ratchet fine-toothed, 72 teeth 250 mm 1/2" socket wrench insert hexagon 10 11 12 13 14 15 17 19 22 24 27 30 32 mm 1/2" spark plug insert 21 mm (13/16") 65 mm, 1/2" socket wrench extension 125 250 mm 1/2" universal joint 65 mm, Enlarging/sliding piece 3/8" x 1/2" 44 mm Bit adaptor 1/2" square x 5/16" hexagon 38 mm Double-jointed key 8x9 10x11 12x13 14x15 mm Combination wrench 8 10 12 13 14 17 mm, Hexagon Key Wrenches, hexagon 1.5 2 2.5 mm | 383 | 83 | 280 | 92 | 5.85 |

R4600 3097
SOCKET SET
1/4"+1/2"
 97 pieces

- > Hand-operated
- > Plastic case in GEDORE red Design

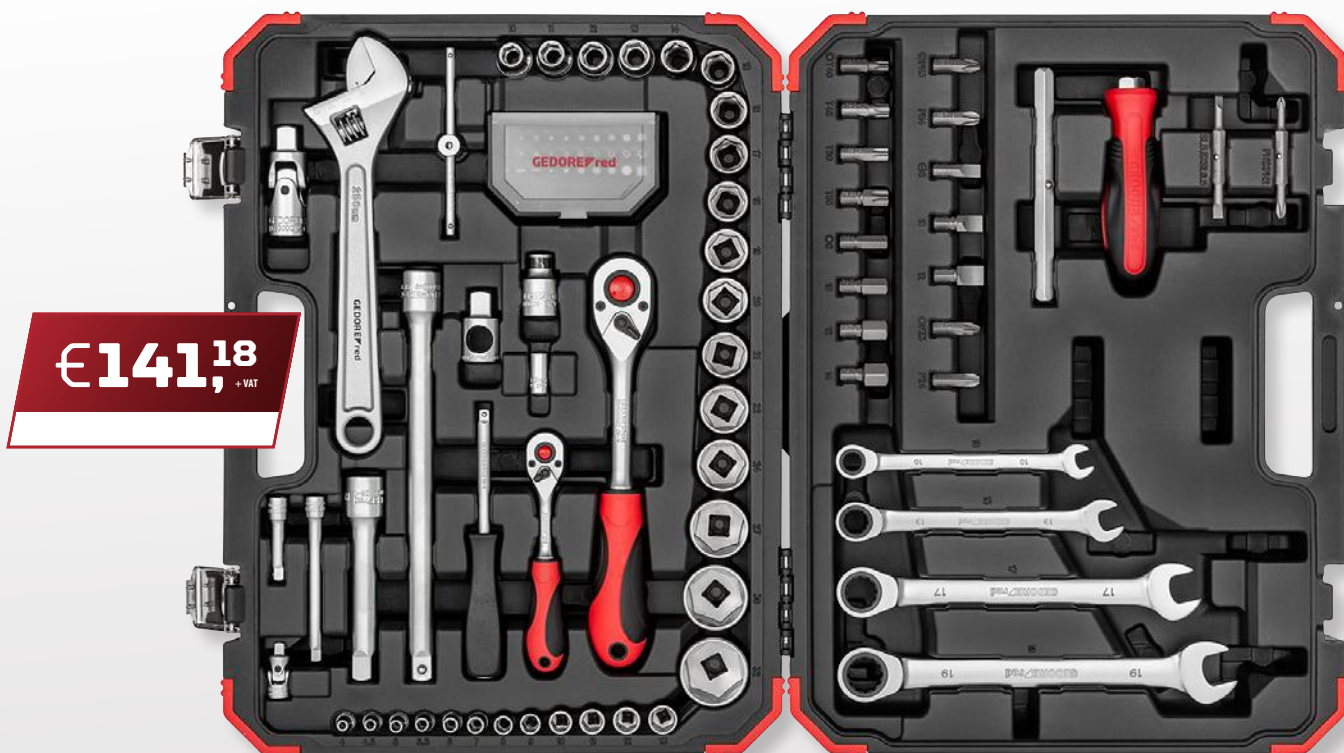

| Code | No. | Contents | Width mm | Height mm | Depth mm | Pieces | Weight kg |
|----------------|-----------|--|----------|-----------|----------|--------|-----------|
| 3300186 | R46003097 | 1/4" 2K lever reversible ratchet L 150 mm 1/4" square handle L 165 mm 1/4" socket, hexagon 4 4.5 5 5.5 6 7 8 9 10 11 12 13 25 mm 1/4" T-handle with slider L 115 mm 1/4" socket wrench extension L 50 100 mm 1/4" universal joint L 33 mm 1/2" 2K reversible ratchet L 250 mm 1/2" socket hex 10 11 12 13 14 15 16 17 18 19 20 21 22 24 38 mm 27 30 32 42 mm 1/2" socket wrench extension L 125 250 mm 1/2" universal joint L 66 mm Magnification Adapter/Slider 3/8" x 1/2" 1/4" bit adapter 1/2" bit adapter 1/4" bits, L25mm, hexagon socket 2 3 4 5 5.5 6 mm, slot 4 5.5 6 mm, PH 1 2 3, PZ 1 2 3, TX T10 T15 T20 T25 T27 T30 T40, TXB T10 T15 T20 T25 T27 T30 T40 5/16" bits L30mm, internal hexagon 8 10 12 14 mm, slot 8 10 12 mm, PH 3 4, PZ 3 4, TX T40 T45 T50 T55 Combination ratchet wrench SW 10 13 17 19 mm 2-component handle Maximus, 5/16" shank with bit double blade PH 1 2, bit double blade 5.5 6.5 mm, bit adapter 8mm (5/16") x 1/4" Adjustable wrench, adjustable 30 mm, L 250 mm | 452 | 86 | 340 | 97 | 8.9 |

R4600 3232
SOCKET SET
1/4"+1/2"
 232 pieces

- › For manually operated screws and bolts
- › Plastic case in GEDORE red Design

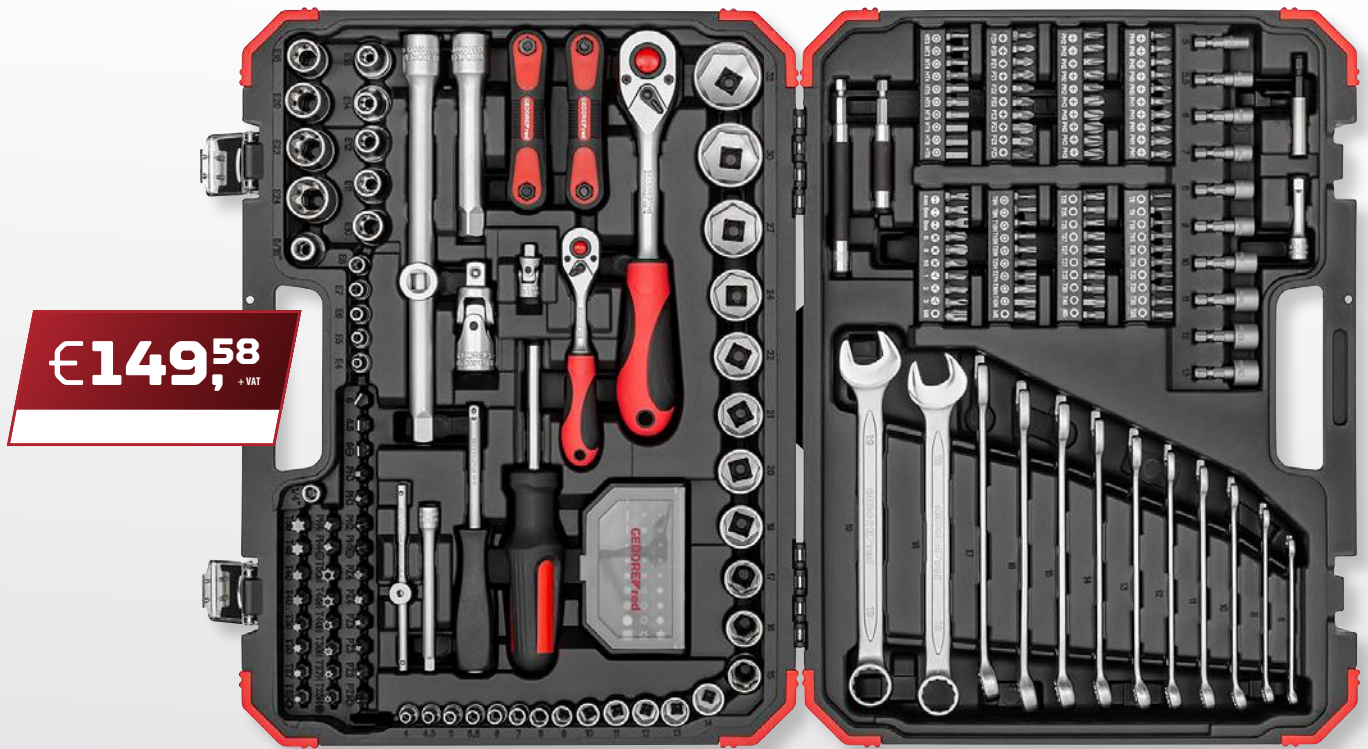

€149,58
 + VAT



| Code | No. | Contents | Width mm | Height mm | Depth mm | Pieces | Weight kg |
|---------|-----------|---|----------|-----------|----------|--------|-----------|
| 3300185 | R46003232 | 2K reversible ratchet 1/4" length 150 mm Return angle 5° 2K reversible ratchet 1/2" length 250 mm Return angle 5° 1/4" sockets SW 4 4.5 5 5.5 6 7 8 9 10 11 12 13 14 25 mm 1/2" sockets SW 15 16 17 19 20 21 22 24 38 mm 1/2" sockets SW 27 30 32 42 mm 1/4" T-handle with slider 1/4" socket wrench extension 50 100 mm 1/2" socket wrench extension 125 - 250 mm 1/4" universal joint length 33 mm 1/2" cardan joint length 66 mm 1/4" square socket handle 165 mm 1/4" sockets TX E4 E5 E6 E7 E8 25mm 1/2" Sockets TX E10 E11 E12 E14 E16 E18 E20 38mm, E22 L 40mm, E24 L41mm Magnification Adapter/Slider 3/8" x 1/2" 1/2" bit adapter square x 5/16" hexagon 1/4" bit screwdriver L 100 mm 1/4" bits 25 mm long: Hexagon socket 3 4 5 6, PH 5x 0 1 2 3 each, PZ 2x 0 1 each 3x 2 3, TX T8 T9 T10 T15 T20 T25 T27 T30 TXB T40 T9 T10 T15 T20 T25 T27 T30 T40 Spanner 5 6 8 XZN 4 6 8 TRI-WING 1 2 3 Torque 6 8 10 1/4" bits hex 38 mm long 5 5.5 6 7 8 9 10 11 12 13 mm 1/4" bit holder 60+80+120mm 30-piece bit box with 1/4" bits, 25 mm long: internal hexagon 2 3 4 5 5.5 6 mm, slot 4 5.5 6 mm, PH 1 2 3, PZ 1 2 3, TX T10 T15 5xT20 4xT27 T30 T40, TXB T10 T15 T20 T25 T27 T30 T40 5/16" bits 30 mm long: slotted 6 6.5 8, PH 1 2 2x3 4 each, PZ 1 2 2x3 4 each, TX T25 T27 T30 T40 T45 T50, TXB T 25 T27 T30 T40 T5 T45 Combination wrench SW 6 8 10 11 12 13 14 15 16 17 18 19 mm Allen key Allen key 1.5 2 2.5 3 4 5 6 8 mm Angle Screwdriver TX T9 T10 T15 T20 T25 T27 T30 T40 Insert holder 1/4" square x 1/4" hex length 25mm | 452 | 86 | 340 | 232 | 8.9 |

R4560 3172
SOCKET SET 1/2"-3/8"-1/4"
 172 pieces

- > For hand-operated screw work
- > Plastic case in GEDORE red Design

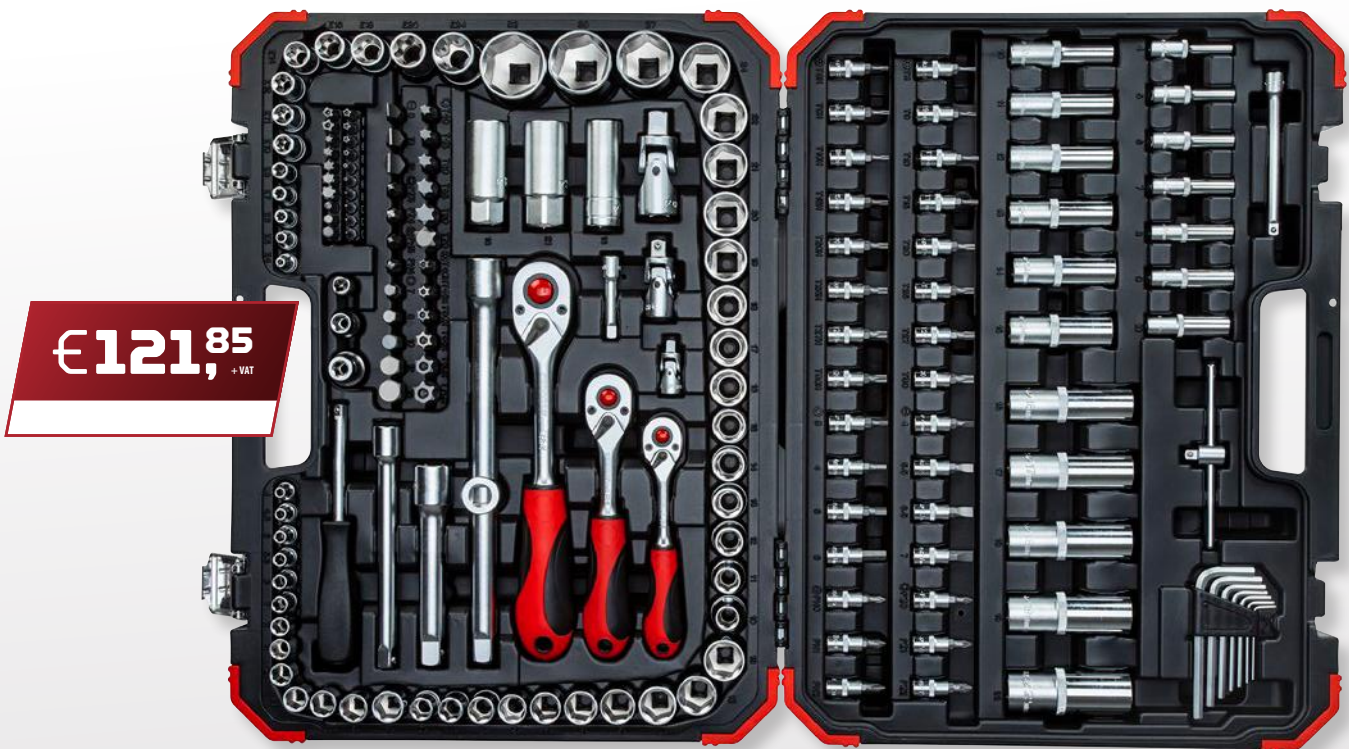

| Code | No. | Contents | Width mm | Height mm | Depth mm | Pieces | Weight kg |
|---------|-----------|--|----------|-----------|----------|--------|-----------|
| 3300058 | R45603172 | 1/4" 2C lever reversible ratchet, fine-toothed, 72 teeth 150 mm 1/4" square plug-in handle 165 mm 1/4" socket wrench insert, hexagon 4 4.5 5 5.5 6 7 8 9 10 11 12 13 14 25 mm 1/4" socket wrench insert hexagon 4 5 6 7 8 9 10 50 mm 1/4" socket wrench insert TX E4 E5 E6 E7 E8 25 mm 1/4" screwdriver bit socket hexagon socket 3 4 5 6 37 mm 1/4" screwdriver bit socket slotted 4 5 5 6 5 7 37 mm 1/4" screwdriver bit socket cross-slotted PH 0 1 2 37 mm 1/4" screwdriver bit socket cross recess PZ 0 1 2 37 mm 1/4" screwdriver bit socket TX T8 T9 T10 T15 T20 T25 T27 T30 37 mm 1/4" screwdriver bit socket TX with bore T8 T9 T10 T15 T20 T25 T27 T30 37 mm 1/4" socket wrench extension 50 100 mm, 1/4" T-handle with slider 115 mm 1/4" universal joint 32 mm bit adapter, 1/4" square x 1/4" hex. 25 mm 1/4" bits TX T5 T6 T7 25 mm, 1/4" bits TX with hole T7 25 mm 1/4" bits TX plus security T10 T15 T20 T25 T27 T30 T40 T45 25 mm 1/4" bits multi-tooth XZN M5 M6 M8 25 mm 1/4" bits keyway M5 M6 M7 M8 M9 25 mm 5/16" bits hexagon socket 7 8 10 12 14 30 mm 5/16" bits slotted 8 10 12 30 mm, 5/16" bits cross recess PH 3 4 30 mm 5/16" bits cross recess PZ 3 4 30 mm, 5/16" bits TX T40 T45 T50 T55 T60 T70 30 mm 5/16" bits TX with bore T40 T45 T50 T55 T60 T70 30 mm 3/8" 2C lever reversible ratchet, fine-toothed, 72 teeth 180 mm 3/8" socket wrench insert hexagon 10 11 12 13 14 15 16 17 18 19 3/8" socket wrench insert hexagon 10 11 12 13 14 15 63 mm 3/8" socket wrench insert TX E10 E11 E12 E14 E16 E18 3/8" spark plug insert 18 mm 65 mm, 3/8" socket wrench extension 150 mm 3/8" universal joint 49 mm, bit adapter 3/8" square x 5/16" hex 30 mm 1/2" 2C lever reversible ratchet, fine-toothed, 72 teeth 250 mm 1/2" socket wrench insert hexagon 10 11 12 13 14 15 16 17 18 19 20 21 22 24 27 30 32 mm 1/2" socket wrench insert 6 -kant 16 17 18 19 22 77 mm, 1/2" socket wrench insert TX E20 E24 1/2" spark plug insert 16 21 mm 65 mm, 1/2" socket wrench extension 125 250 mm 1/2" universal joint 66 mm, Enlarging piece / sliding piece 3/8" x 1/2" 44 mm Bit adapter 1/2" square x 5/16" hex 38 mm Offset screwdriver set hexagon 1.5 2.2 5 3 4 5 6 mm | 450 | 93 | 345 | 172 | 10.5 |

BIKE TOOL FOR ON THE GO

The "On the Road" bike set is a practical emergency set with bicycle tools for on the go. Small repairs are done in no time at all.

The **GEDORE red bike set R21702013** is the help you need when you break down on the way. So that you can continue quickly, the included bits can be used to tighten and tighten screw connections on the bike, the selection of bits and socket wrenches is a tailored solution. Working with the ratchet with bit adapter is much more pleasant and practical than with conventional Allen keys or multi-tools. Difficult-to-reach screw connections in particular are much easier to reach with the handy ratchet bit. Thanks to the ratchet mechanism, using the bit ratchet means that you can avoid repeated „application“ on the screw connections - an immense plus in terms of convenience and speed.

Three tire levers make the work of patching tyres and tubes much easier. Housed in an attachable bag for the saddle tube, the set is a practical companion on every tour.



Bike-Set „On road“ R21702013

1

PRACTICAL RATCHET BIT WITH ACCESSORIES

- The fine-toothed bit ratchet can hold bits directly or with a bit holder. With an adapter piece, it is even possible to use socket wrench inserts

2

SAFELY STOWED

- High-quality, robust bag with a plastic zipper. No rattling on the frame or the seat post on the way

3

PERFECT KIT IN THE EVENT OF A FLAT TIRE

- The three tire levers included in the set can be fixed to the rim and allow access to the leak in the tube

**IDEAL
COMPANION**

"The set includes everything I need in terms of tools for flat tires or small repairs when I'm on my bike. The ratchet bit is particularly useful."



NEW

R2170 2013
ON THE ROAD BIKE SET
 13 pieces



€33,27
 + VAT



- > Ergonomic handling with bit ratchet and bit adapter
- > Selection of bits and sockets tailored to the screws and nuts on a bike
- > Clampable bag on the saddle and seat post
- > No disturbing noises when driving thanks to the plastic zipper



| Code | No. | Contents | Width mm | Height mm | Depth mm | Pieces | Weight kg |
|---------|-----------|---|----------|-----------|----------|--------|-----------|
| 3300194 | R21702013 | Tire lever set, 3 pieces Allen bit 3 4 5 6 Slotted bit PH1 TX Bit T25 Socket wrench insert 10 mm Ratchet 1/4" drive adapter Bit holder with quick release system 66.5 mm pocket | 90 | 145 | 54 | 13 | 0.24 |

THE MOBILE BICYCLE WORKSHOP

Whether mobile or in the workshop - with the bike set „workshop“ you are well prepared for repairs on the bike.

The **GEDORE red bike set workshop R21702025** includes, as a professional basis, telephone pliers for gripping, e.g. Bowden cables and side cutters for separating these cables. Both pliers are equipped with 2-component handles and have induction-hardened cutting edges. The extra slim cone adjustable wrench is specially designed for screw connections on pedals or the rear brakes on the bicycle. The maintenance and adjustment of systems on modern bicycles such as mountain bikes or racing bikes, but also e-bikes, requires professional tools, especially for the screw connections that are difficult to access. In addition to the bit screwdriver, the handy bit ratchet is also helpful for screw connections that are particularly difficult to access. This can be used with or

without a bit adapter – depending on the space available. The set is completed by a selection of bits in the sizes most commonly used on bikes. All tools are housed in a practical, handy and high-quality bag.



Bike-Set „workshop“ R21702025

1 HANDY

- Professional pliers with hardened cutting edges and ergonomic handles

2 FOR TIGHT WORKING ENVIRONMENTS

- Cone adjustable wrench as a solution for loosening screw connections in tight work space

3 PRACTICAL RATCHET BIT WITH ACCESSORIES

- The fine-toothed bit ratchet can hold bits directly or with a bit adapter

4 VALUABLE IN THE EVENT OF A FLAT TIRE

- The three tire levers included in the set can be fixed to the rim and allow access to the leak in the tube



FULL CONTROL ON THE BIKE

"With this set I not only have the screw connections under control. This makes me feel completely safe!"



NEW

R2170 2025
WORKSHOP BIKE SET
 25 pieces

- › Cone adjustable wrench for narrow screw connections
- › Handle or ratchet bit
- › Selection of 1/4" bits and sockets
- › In a quality bag



| Code | No. | Contents | Width mm | Height mm | Depth mm | Pieces | Weight kg |
|---------|-----------|--|----------|-----------|----------|--------|-----------|
| 3300195 | R21702025 | Tyre lever set, 3 pieces Cone roller fork spanner 6" Flat round nose pliers 160 mm Side cutter 160 mm Internal hexagon bit 2.2.5 3 4 5 6 8 10 Cross-recess bit PH1 Slotted head bit 4 TX bit T15 T29 T25 T30 Socket spanner 10 mm Ratchet 1/4" 91 mm Drive adapter 1/4" hex x 1/4" square Bit screwdriver 1/4", 118 mm Bit holder with quick release system 66.5 mm Bag 230 x 190 x 50 mm | 205 | 235 | 50 | 25 | 1.07 |

R3800 3043
TOOL SET
**„MEASURING-
 CUTTING-SCREWS“**
 43 pieces

€111,76
 + VAT



- For manually operated screws and bolts
- Plastic case in GEDORE red Design

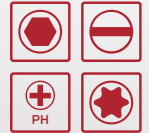

| Code | No. | Contents | Width mm | Height mm | Depth mm | Pieces | Weight kg |
|---------|-----------|--|----------|-----------|----------|--------|-----------|
| 3300190 | R38003043 | Screwdriver slotted 3 x 75 mm Screwdriver slotted with percussion cap 4x75 mm, 5.5x100 mm, 6.5x125 mm Phillips screwdriver with impact cap PH 1x75 mm, PH 2x100 mm 9-piece offset screwdriver set, hexagon socket, 1.5 2 2.5 3 4 5 6 8 10 long Offset screwdriver set 9 pcs TX T10 T15 T20 T25 T27 T30 T40 T45 T50 Tape measure, 5m, side cutters, Needle nose pliers straight, combination pliers Level 300mm, Cutter knife incl. 3 blades, 10 replacement blades for cutter knives | 383 | 80 | 272 | 43 | 6.2 |

R4600 7138
UNIVERSAL SET
ALLROUND IN
TOOL CASE
 138 pieces



Kneeboard



- For manually operated screws and bolts
- Aluminium case in GEDORE red design

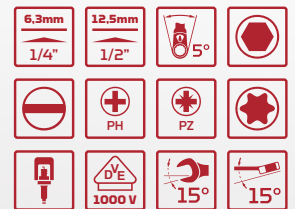

| Code | No. | Contents | Width mm | Height mm | Depth mm | Pieces | Weight kg |
|---------|-----------|--|----------|-----------|----------|--------|-----------|
| 3300189 | R46007138 | 2K lever reversible ratchet 1/4" fine-toothed, 72 teeth 150 mm 2K lever reversible ratchet 1/2" fine-toothed, 72 teeth 250 mm 1/4" socket wrench insert hexagon SW 4 4.5 5 5.5 6 7 8 9 10 11 12 13 14 25 mm 1/2" socket wrench insert hexagon SW 10 13 14 16 17 18 19 20 22 24 38 mm 1/2" socket wrench insert hexagon SW 27 30 32 42 mm 1/4" socket wrench extensions 50 100 mm, 1/2" socket wrench extensions 125 250mm 1/4" square plug-in handle 165 mm, 1/2" spark plug socket SW 16 24 65 mm 1/4" T-handle with slider 115 mm, 1/4" universal joint 33 mm, 1/2" universal joint 66 mm Drive adapter 1/4" internal square x 1/4" hexagon 25mm Drive adapter 1/4" square x 1/4" hex 50mm Combination wrench SW 8 9 10 11 13 14 17 19 mm Adjustable wrench, adjustable 10" 250 mm Allen key set hexagon SW 2 2.5 3 4 5 6 8 10 mm Allen key set TX. long SW T10 T15 T20 T25 T30 T40 T45 T50 Slotted screwdriver 5.5 6.5 8, Screwdriver Phillips PH 1 2, VDE screwdriver PH 2 PZ 2 Phase tester slot 120-250 V, 1/4" ratchet screwdriver 1/4" bit box internal hexagon SW 2 3 4 5 5.5 6 mm, slot 4 5.5 6 mm, PH 1 2 3, PZ 1 2 3, TX T10 T15 T20 T25 T27 T30 T40, TXB T10 T15 T20 T25 T27 T30 T40 Combination pliers 180 mm, Side cutters 160 mm, Needle nose pliers 200 mm Water pump pliers 250 mm, Crimping tool and plastic box with accessories 40 pcs. File, half-round, cut 2 200mm, LED Flashlight 175mm, Chisel set in plastic holder, 5 pieces Cutter knife with 10 spare blades, Hacksaw 150 mm, plus 3 spare saw blades Machinist's hammer 300 g, Tape measure, 5 m Universal scissors, blade length 60 mm, kneeboard, spirit level 300mm | 455 | 157 | 355 | 138 | 13 |



R6900 3000
WHEEL CHANGE SET
 3 pieces

€188,²⁴
 + VAT



- > For controlled tightening of screws
- > R68900200: Controlled and precision screw tightening from 40 to 200 Nm
- > With test certificate according to DIN EN ISO 6789
- > R60010027: Can be extended in five stages from 460 mm to up to 600 mm
- > R63043003: In 17, 19 and 21 with color coding
- > In acc. with DIN 3120 - C12,5, ISO 1174, with ball locking device
- > Acc. to DIN 3129, ISO 2725-2



| Code | No. | Contents | Pieces | Weight kg |
|---------|-----------|---|--------|-----------|
| 3300187 | R69003000 | R68900200 Torque wrench 1/2" 40-200 Nm R60010027 2K telescopic ratchet 1/2" switchable R63043003 Impact wrench socket set 1/2" 3 pieces | 3 | 3.3 |

R4017 0027 2C-SWIVEL HEAD BIT RATCHET

reversible

- › Ratchet head swivels through 180°
- › Lockable in 5 positions
- › With magnetic holder
- › Lever for reversible clockwise/anticlockwise operation
- › In-hex for direct mounting of bits as per DIN ISO 1173



€33,27
+ VAT



| Code | No. | Drive connector hexagon female | Drive connector hexagon female mm | Return angle | Total length mm | Weight kg |
|---------|-----------|--------------------------------|-----------------------------------|--------------|-----------------|-----------|
| 3300160 | R40170027 | 1/4" | 6,3 | 5 ° | 165 | 0.13 |

R4005 0009 2C-REVERSIBLE RATCHET 1/4"

cranked

- › Cranked version
- › Lever for reversible clockwise/anticlockwise operation
- › Push-button release
- › For sockets, accessories etc. with square drive as per DIN 3120 - C 6.3, ISO 1174, with ball retention groove



€22,76
+ VAT



| Code | No. | Drive connector square | Drive connector square mm | Return angle | Total length mm | Weight kg |
|---------|-----------|------------------------|---------------------------|--------------|-----------------|-----------|
| 3300159 | R40050009 | 1/4" | 6,3 | 10 ° | 146 | 0.1 |

R5005 0009 2C-REVERSIBLE RATCHET 3/8"

cranked

- › Offset pattern for in-depth screw work
- › Lever for reversible clockwise/anticlockwise operation
- › Push-button release
- › For sockets, accessories etc. with square drive as per DIN 3120 - C 10, ISO 1174, with ball retention groove



€30,41
+ VAT



| Code | No. | Drive connector square | Drive connector square mm | Return angle | Total length mm | Weight kg |
|---------|-----------|------------------------|---------------------------|--------------|-----------------|-----------|
| 3300225 | R50050009 | 3/8" | 10 | 10 ° | 210 | 0.226 |

R6005 0009
2C-REVERSIBLE RATCHET 1/2"
 cranked

€31,34
 + VAT



- › Offset pattern for in-depth screw work
- › Lever for reversible clockwise/anticlockwise operation
- › Push-button release
- › For sockets, accessories etc. with square drive as per DIN 3120 - C 12,5, ISO 1174, with ball retention groove



| Code | No. | Drive connector square | Drive connector square mm | Return angle | Total length mm | Weight kg |
|---------|-----------|------------------------|---------------------------|--------------|-----------------|-----------|
| 3300411 | R60050009 | 1/2" | 12,5 | 10° | 253 | 0.514 |

R6011 0009
2C-SWIVEL-HEAD
TELESCOPIC RATCHET 1/2"
 reversible

€45,54
 + VAT



- › Telescopic ratchet lockable in 5 positions
- › Ratchet head swivels through 180°
- › Ring for reversing clockwise/anticlockwise direction
- › For sockets, accessories etc. with square drive as per DIN 3120 - C 12,5, ISO 1174, with ball retention groove



| Code | No. | Square drive inch | Square drive mm | variable length | Return angle | Number of teeth | Weight kg |
|---------|-----------|-------------------|-----------------|-----------------|--------------|-----------------|-----------|
| 3300523 | R60110009 | 1/2" | 12,5 | 430-580 | 10° | 36 | 1.292 |

R6012 0027
2C-SWIVEL HEAD
REVERSIBLE RATCHET

€37,97
 + VAT



- › Ratchet head swivels through 180°
- › Lockable in 5 positions
- › Lever for reversible clockwise/anticlockwise operation
- › Push-button release
- › For sockets, accessories etc. with square drive as per DIN 3120 - C 12,5, ISO 1174, with ball retention groove



| Code | No. | Drive connector square | Drive connector square mm | Return angle | Total length mm | Weight kg |
|---------|-----------|------------------------|---------------------------|--------------|-----------------|-----------|
| 3300409 | R60120027 | 1/2" | 12,5 | 5° | 290 | 0.633 |

R6255 8010 SCREWDRIVER BIT SOCKETS 1/2" ON HOLDING RAIL

10 pieces



€66,46
+ VAT



- > Screwdriver bit socket 1/2", hexagon socket, design according to DIN 7422
- > Hand-operated, knurled grip

| Code | No. | Contents | Length mm | Pieces | Weight kg |
|---------|-----------|----------------------------------|-----------|--------|-----------|
| 3300023 | R62558010 | 5 6 7 8 9 10 11 12 14 17 55 mm | 280 | 10 | 1.1 |

RX890 XXXX TORQUE WRENCH 10-100 Nm

- > Controlled tightening from 10 to 100 Nm
- > Audible Torque triggering can clearly be heard and felt
- > Right-hand and left-hand tightening by changing the mushroom head / push-through square
- > Adjustable torque wrench with square drive and integrated ratchet function
- > Tripping accuracy: +/-3 % tolerance of the set scale value

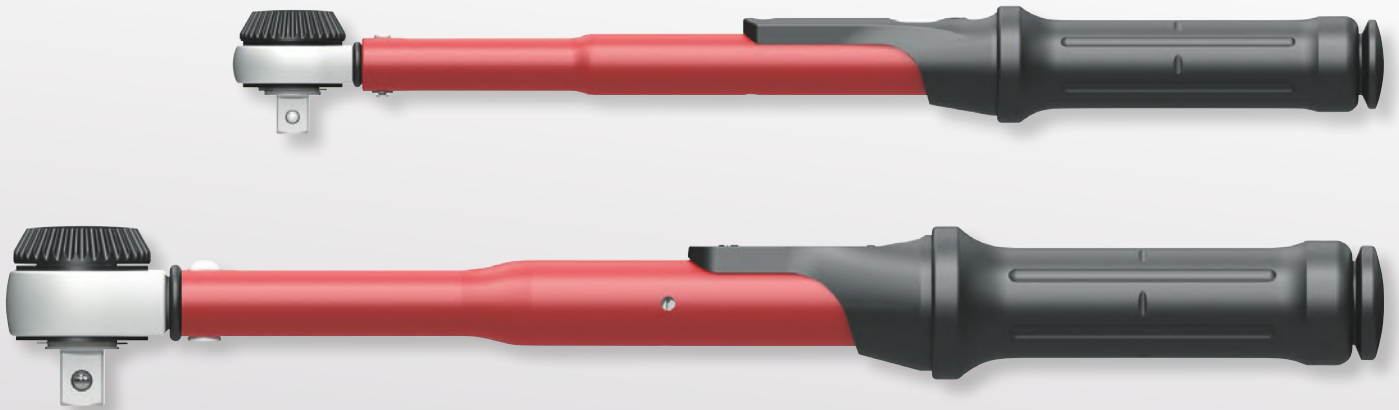

from

€122,69
+ VAT

| Code | No. | Type | Square drive inch | Square drive metric mm | Nm | Nonius | Height mm | Housing - square centre spacing mm | Length mm | Head width mm | Head height mm | Weight kg | excl. VAT |
|---------|-----------|-----------------------------------|-------------------|------------------------|--------|--------|-----------|------------------------------------|-----------|---------------|----------------|-----------|-----------|
| 3301871 | R58900050 | Push-through square with pin | 3/8" | 10 | 10-50 | 2,5 | 34 | 17,5 | 330 | 35,0 | 25,3 | 0.476 | 122,69 |
| 3301216 | R68900100 | square socket with knob, serrated | 1/2" | 12,5 | 20-100 | 5 | 51,5 | 22 | 395 | 46,0 | 35,9 | 1.176 | 131,93 |

R3800 2006
SCREWDRIVER
SET
 6 pieces

€20,92
 + VAT



- › Blades of high-grade chrome-molybdenum steel, chrome-plated
- › 2-component-handle for a hands-friendly transfer of force
- › 5-sided grip heads prevent rolling away



| Code | No. | Contents |
|---------|-----------|--|
| 3301270 | R38002006 | Slotted screwdriver 3 5.5 6.5 mm, Cross-slotted screwdriver PH 0 1 2 |

| Pieces | Weight kg |
|--------|-----------|
| 6 | 0.435 |

R3840 2006
SCREWDRIVER SET TX
 6 pieces

€23,77
 + VAT



- › Blades of high-grade chrome-molybdenum steel, chrome-plated
- › 2-component-handle for a hands-friendly transfer of force
- › 5-edge handle heads prevent them rolling off when put down



| Code | No. | Contents |
|---------|-----------|--|
| 3301272 | R38402006 | TX screwdriver T10 T15 T20 T25 T30 T40 |

| Pieces | Weight kg |
|--------|-----------|
| 6 | 0.55 |

R3867 2006
2GT-SCREWDRIVER
SET
 In-hex, 6 pieces

€31,84
 + VAT

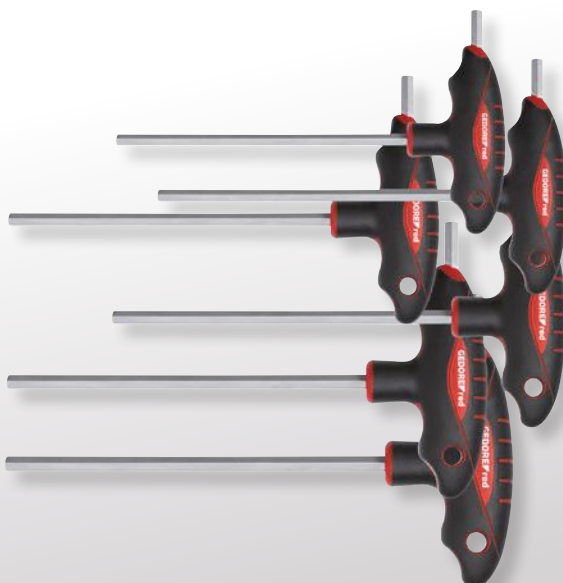

- › Two-way profile
- › 2-component-handles for an easy transfer of force



| Code | No. | Contents |
|---------|-----------|-------------------------------------|
| 3301281 | R38672006 | Hexagon socket key 2.5 3 4 5 6 8 mm |

| Pieces | Weight kg |
|--------|-----------|
| 6 | 0.731 |

COLOURFUL CLASSIC

The 9-piece offset screwdriver sets add colour to everyday work and help you choose the right size.

The 9-piece **GEDORE red offset screwdriver sets R36401009 and R36601009** are perfect for tightening or loosening TX and Allen screws. With the 9 most common sizes (T10 - T50 or 1.5-10mm), the most important fastening work in everyday life can be processed. The round shape flatters the hand and ensures more comfortable handling, even in continuous use. The extra long handle makes loosening and tightening easier thanks to the improved leverage. The sets are

rounded off by the colour coding, which helps to find the right size quickly in everyday life. Both sets come safely stowed away in a plastic holder with a practical belt clip. This can be opened for easier removal.



Offset screwdriver sets TX/IN TX/IN R36401009 and R36601009

1

PLEASANT HANDLING

- The round shape fits better in the hand and is more comfortable during longer screw fastening jobs

2

TIME SAVING

- The colour coding and size marking saves time when looking for the right offset screwdriver

3

COMFORTABLE WORKING

- The extra long design results in better leverage and makes loosening and tightening easier. The ball head provides flexibility when space around the fitting is tight



"Tidy classics with colour coding, which makes it easier to find the right size."

NEW

R3640 1009 ANGLE SCREWDRIVER SET TX WITH COLOUR CODING

9 parts, long



- > Colour coded plastic coating to find the right L-key faster
- > Round shape
- > Long version
- > Matt chrome
- > In a foldable holder with belt clip



| Code | No. | Contents |
|---------|-----------|-------------------------------------|
| 3301333 | R36401009 | T10 T15 T20 T25 T27 T30 T40 T45 T50 |

| Pieces | Weight kg |
|--------|-----------|
| 9 | 0.6 |

R3660 1009 ANGLE SCREWDRIVER SET IN WITH COLOUR CODING

9 parts, long



- > Colour coded plastic coating to find the right L-key faster
- > Round shape
- > Long version
- > Matt chrome
- > In a foldable holder with belt clip



| Code | No. | Contents |
|---------|-----------|---------------------------|
| 3301332 | R36601009 | 1.5 2 2.5 3 4 5 6 8 10 mm |

| Pieces | Weight kg |
|--------|-----------|
| 9 | 0.6 |

R3891 0000 RATCHET SCREWDRIVER 1/4" with telescopic blade



- > Adjustable telescopic blade
- > Quick-grip system for hex bits as per DIN 3126 - C 6.3 + E 6.3 (1/4")
- > Reversible clockwise/anticlockwise ratchet function
- > Ratchet lock in central position

€17,13 + VAT



| Code | No. | Drive connector hexagon female | Drive connector hexagon female mm | variable blade length mm | variable length | Weight kg |
|---------|-----------|--------------------------------|-----------------------------------|--------------------------|-----------------|-----------|
| 3301341 | R38910000 | 1/4" | 6,3 | 0 - 100 | 183-287 | 0.223 |

THE SPACE MIRACLE AMONG THE TOOL TROLLEYS

The workshop trolley GEDWorker offers flexible access from both sides and plenty of space.

The **GEDORE red workshop trolley GEDWorker R20152205** is a flexible companion in everyday work. Thanks to the drawer extension on both sides, the tool can be removed from both sides without having to turn it over. Thanks to the external fixed castors, stability is increased and the risk of tipping is reduced to a minimum. In addition, rollers and chassis offer a high level of driving comfort, even with a high load. The small parts compartments in the plastic lid offer another storage option. In this way, tools and materials can be stored in an orderly manner and are quick to hand. If you are still looking for the right tool, you will find a large selection of predefined tool sets for different applications in the 1/3 and 2/3 foam modules from the **GEDORE red** range.



Workshop trolley GEDWorker R20152205

1

LITTLE HELPERS

- Small parts compartments in the plastic lid enable pre-sorted storage for tools and materials. This provides a better overview during use

2

FLEXIBLE ACCESS

- The pull-out drawers on both sides ensure access from both sides at all times without having to turn the trolley

3

DURABLE

- The powder coating offers a high level of protection against corrosion and is particularly resistant to scratches

4

HIGH SECURITY

- The external fixed castors ensure that the workshop trolley cannot tip over and also offer better driving characteristics, especially when carrying a full load



"The GEDWorker particularly impresses with the flexible access from both sides. Together with the plenty of storage space and the comfortable driving characteristics, it is a practical helper for a stressful day at work."



NEW

R2015 2205
WORKSHOP TROLLEY
GEDWORKER
 with 5 drawers

€385,71
 + VAT



- > Sheet steel, corrosion-resistant and scratch-resistant powder-coated
- > Working platform with cover made of ABS plastic with 3 compartments for small parts
- > Manoeuvrable and easy to control thanks to the driving and steering handle
- > Central locking system
- > Ball bearing guide rails
- > All drawers can be pulled out on both sides
- > Load capacity per drawer 20 kg
- > Additional storage compartment for larger items below the last drawer
- > Even under maximum loads, the GEDORE trapezoidal axle construction ensures: smooth running, maneuverability and directional stability

Made in Austria



| Code | No. | RAL | Height mm | Width mm | Depth mm | Drawers | Max. load-bearing capacity kg | Number of drawers | Weight kg |
|---------|-----------|----------|-----------|----------|----------|---------------------------------------|-------------------------------|-------------------|-----------|
| 3301675 | R20152205 | RAL 9005 | 963 | 685 | 462 | 2xType 1, H=74mm 3xType 2, H=119mm | 200 | 5 | 41 |

WELL POSITIONED FROM THE GROUND UP!

The filled workshop trolley scores with its extensive 119-piece basic equipment for everyone.

The equipped **tool trolley R21562005** is ideally suited as a basic range for beginners in all professional groups. Around the core, consisting of the ratchets in 1/4" and 1/2" with accessories, is built up with screwdrivers, pliers, wrenches, etc., the scope of which leaves nothing to be desired. Thanks to the two-sided pull-out drawer, the tools can be removed from both sides of the workshop trolley without having to turn it over. The external fixed castors increase stability and reduce the risk of tipping to a minimum. In addition, rollers and chassis offer a high level of driving comfort, even with a high load. The small parts compartments in the plastic lid offer another storage option. In this way, tools and materials can be stored in an orderly manner and are quick to hand.



Tool trolley with 119-piece assortment R21562005

1

LITTLE HELPERS

- Small parts compartments in the plastic lid enable pre-sorted storage for tools and materials. This provides a better overview during use

2

HIGH SECURITY

- The external fixed castors ensure that the workshop trolley cannot tip over and also offer better driving characteristics, especially when carrying a full load

3

FLEXIBLE ACCESS

- The pull-out drawers on both sides ensure access from both sides at all times without having to turn the trolley

4

EXTENSIVE EQUIPMENT

- In addition to the complete 1/4" + 1/2" socket wrench sets, the comprehensive tool kit includes wrench sets, pliers, screwdrivers and much more



"The GEDWorker workshop trolley particularly impresses with its flexible access from both sides. With its 119-piece assembly, you are well prepared to get started!"

R2156 2005
TOOL SET IN WORKSHOP
TROLLEY GEDWORKER
 119 pieces

- › As basic equipment for the workshop, basic range for beginners of all professional groups or the experienced
- › Metric dimension tools
- › Clearly arranged in GEDORE red foam modules
- › With check tool system: Completeness check using 2-colored foam inserts

Detailed listing of the range contents on page 66

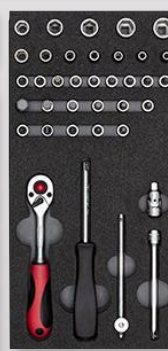
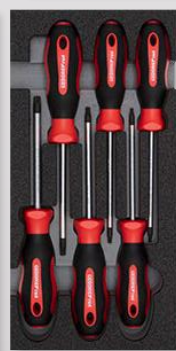
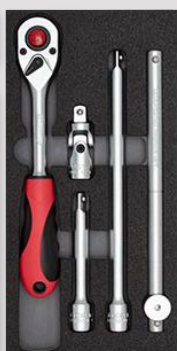

Made in Austria



| Code | No. | RAL | Height mm | Width mm | Depth mm | Drawers | Max. load-bearing capacity kg | Number of drawers | Pieces | Weight kg |
|---------|-----------|----------|-----------|----------|----------|---------------------------------------|-------------------------------|-------------------|--------|-----------|
| 3301676 | R21562005 | RAL 9005 | 963 | 685 | 462 | 2xType 1, H=74mm 3xType 2, H=119mm | 200 | 5 | 119 | 55.46 |

THE ORGANIZED COMPANION

Manoeuvrable and safe workshop trolley with lots of storage space and load capacity.

The **workshop trolley GEDMaster R20202207** from **GEDORE red** is a strong and safe helper at the workplace. With a total load capacity of 400 kg and 7 drawers, the tool trolley offers enough capacity for everyday tools. Thanks to the ball-bearing guide rails, the drawers offer a comfortable extension and each have a load capacity of 40 kg. In addition to the central locking, each drawer is equipped with an individual lock to prevent accidental opening while driving. The additional full extension allows access to the entire contents of the drawer at any time. The workshop trolley is rounded off by the proven GEDORE trapezoidal axle construction. This means that the workshop trolley remains easy to maneuver even under maximum load and maintains its good driving characteristics. The Euro perforation on the side walls offers additional attachment options for accessories and tools. The small parts compartments in the plastic lid enable neat storage on the work surface.



Workshop trolley GEDMaster R20202207

1

LITTLE HELPERS

- Small parts compartments in the plastic lid enable pre-sorted storage for tools and materials. This provides a better overview during use

2

HIGH LOAD CAPACITY

- Ball-bearing guide rails and a solid construction enable a high load capacity of 40 kg per drawer and a comfortable extension

3

SAFE CARGO

- The drawers are secured against unintentional opening while driving due to the individual locking

4

AGILE AND SMOOTH-RUNNING

- The GEDORE trapezoidal axle construction ensures excellent driving characteristics even under maximum loads. This makes the trolley easy and manoeuvrable to manoeuvre



"The manoeuvrable trolley is a great help in the workplace thanks to its storage space and carrying capacity. Not only does a lot of tool equipment go in here, the trolley is also incredibly variable."



NEW

R2020 2207
WORKSHOP TROLLEY
GEDMASTER
 with 7 drawers



- > Sheet steel, corrosion-resistant and scratch-resistant powder-coated
- > Working platform with cover made of ABS plastic with 4 compartments for small parts
- > Manoeuvrable and easy to control thanks to the driving and steering handle
- > Side panels with Euro perforation 10 x 38 mm for attaching accessories
- > Central locking with cylinder lock
- > Safety lock for each drawer, one-handed operation
- > All drawers with full extension and ball bearing guide rails
- > Load capacity per drawer 40 kg
- > Even under maximum loads, the GEDORE trapezoidal axle construction ensures: smooth running, maneuverability and directional stability

€671,43
 + VAT

Made in Austria



| Code | No. | RAL | Height mm | Width mm | Depth mm | Drawers | Max. load-bearing capacity kg | Number of drawers | Weight kg |
|----------------|-----------|----------|-----------|----------|----------|---------------------------------------|-------------------------------|-------------------|-----------|
| 3301677 | R20202207 | RAL 9005 | 999 | 790 | 470 | 5xType 1, H=70mm 2xType 2, H=145mm | 400 | 7 | 65 |

MANOEUVRABLE HELPER WITH GIGANTIC EQUIPMENT!

The equipped workshop trolley offers everything your heart desires with its generous 273-part equipment.

The filled **tool trolley R22071005** is suitable for versatile use in the workshop. The generous range of 1/2", 3/8" and 1/4" socket wrench sets including accessories, pliers wrenches, ratchet screwdrivers, wrenches and much more. make the screwdriver

heart beat faster. The drawers offer a comfortable pull-out thanks to the ball-bearing guide rails and each have a load capacity of 40 kg. In addition to the central locking, each drawer is equipped with an individual lock to prevent accidental opening while driving. The workshop trolley is rounded off by the proven GEDORE trapezoidal axle construction. This means that the workshop trolley remains easy to manoeuvre even under maximum load and maintains its good driving characteristics.

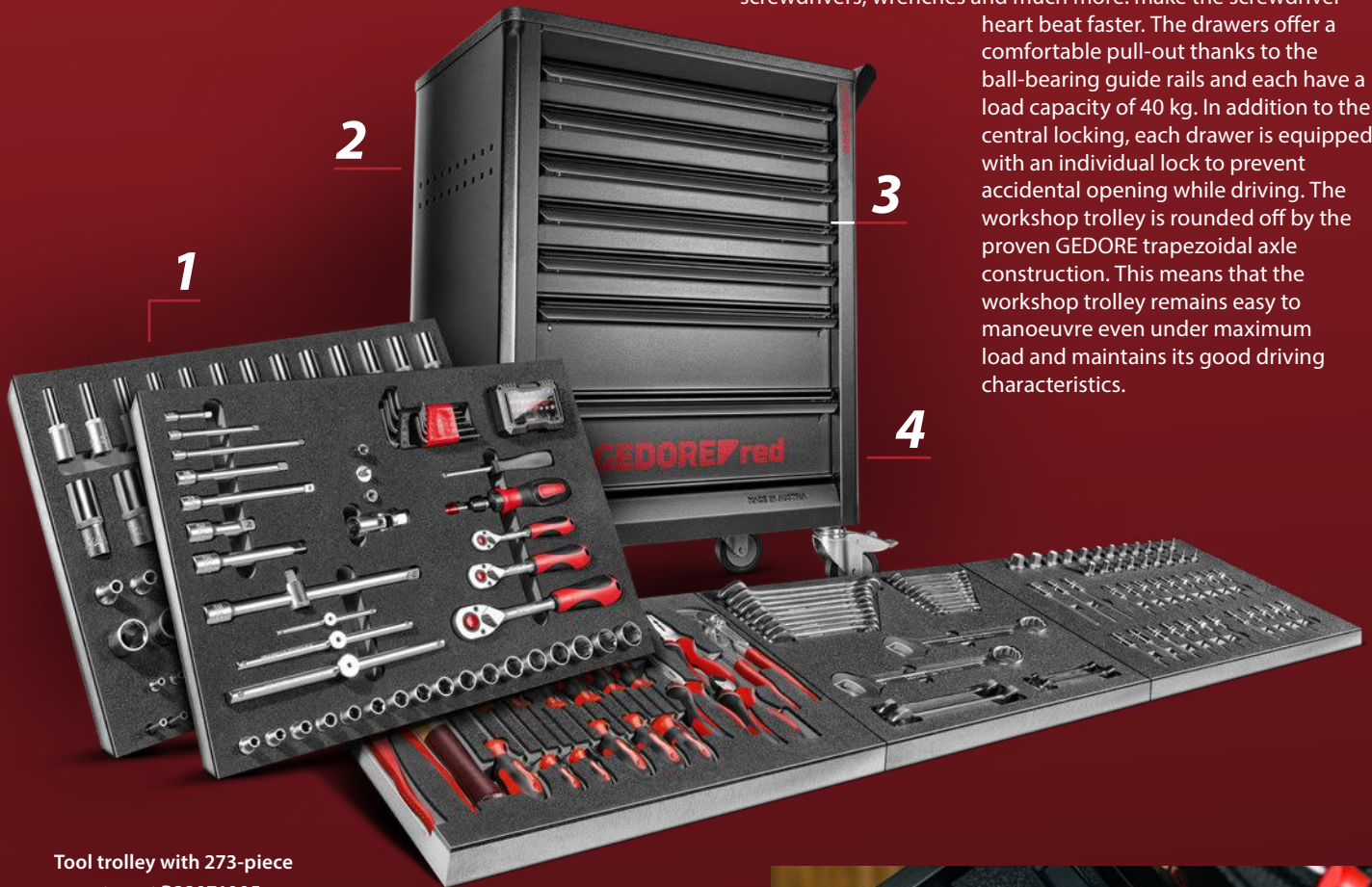

Tool trolley with 273-piece assortment R22071005

1 GENEROUS EQUIPMENT

- In addition to complete 1/2" + 3/8" + 1/4" socket wrench sets, wrench sets, pliers wrenches, ratchet screwdrivers and much more, the generous range of tools includes

2 SAFE CARGO

- The drawers are secured against unintentional opening while driving due to the individual locking

3 HIGH LOAD CAPACITY

- Ball-bearing guide rails and a solid construction enable a high load capacity of 40 kg per drawer and a comfortable extension

4 AGILE AND EASY-GOING

- The GEDORE trapezoidal axle construction ensures excellent driving characteristics even under maximum loads. This makes the trolley easy to manoeuvre



„A great duo - the tool trolley offers extensive storage space and carrying capacity, while the generous range of tools offers everything you need.“

R2207 1005
TOOL SET IN WORKSHOP TROLLEY
GEDMASTER
 273 pieces



€1536,97
 + VAT

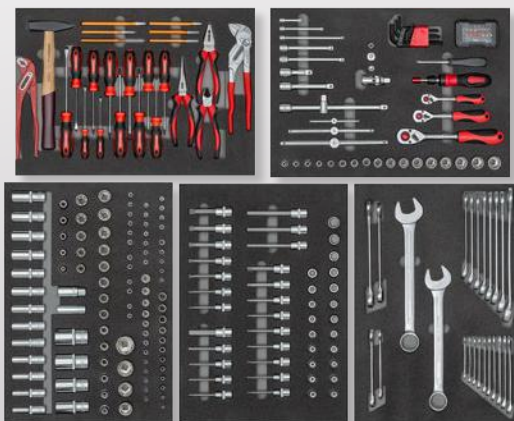

- › Extensive range for industry, trade, automotive and the advanced do-it-yourselfer
- › Metric dimension tools
- › Clearly arranged in GEDORE red foam modules
- › With check tool system: Completeness check using 2-colored foam inserts

Detailed listing of the range contents on page 67

Made in Austria



| Code | No. | RAL | Height mm | Width mm | Depth mm | Drawers | Max. load-bearing capacity kg | Number of drawers | Pieces | Weight kg |
|---------|-----------|----------|-----------|----------|----------|---------------------------------------|-------------------------------|-------------------|--------|-----------|
| 3301678 | R22071005 | RAL 9005 | 999 | 790 | 470 | 5xType 1, H=70mm 2xType 2, H=145mm | 400 | 7 | 273 | 88.5 |

R2040 0006
TOOL TROLLEY MECHANIC PLUS
 with 6 drawers



€662,18
 + VAT

- › Large storage space with adjustable shelf, separately lockable
- › Strong, sheet steel construction, torsionally rigid, designed to take high loads
- › Storage compartment on the left with shelf. Interior dimensions H 720 x W 355 x D 380 mm
- › Door, left-hand door stop, lockable, H 670 x B 310 mm
- › 6 drawers with telescopic fully extending runners, with individual locking (one-hand operation)
- › Load capacity 25 kg per drawer, variable partitionable
- › Central locking with cylinder lock with 4 keys



| Code | No. | RAL | Height mm | Width mm | Depth mm | Drawers | Max. load-bearing capacity kg | Number of drawers | Shelves | Worktop thickness mm | Weight kg |
|---------|-----------|-------------|-----------|----------|----------|---|-------------------------------|-------------------|---------|----------------------|-----------|
| 3301818 | R20400006 | 3020 / 7016 | 915 | 515 | 515 | 4 x H 69 mm 1 x H 144 mm 1 x H 218 mm | 210 | 6 | 1 | 30 | 81 |

R9212 XXXX
ENGINEERS' HAMMER
 with fibreglass

- > Forged hammer head, made of tempered steel
- > Inductively hardened face
- > Nearly unbreakable fibreglass handle

from

€11,50
 + VAT



| Code | No. | Head weight g | Length mm | Weight kg | excl. VAT |
|---------|-----------|---------------|-----------|-----------|-----------|
| 3300720 | R92120012 | 300 | 297 | 0.48 | 11,50 |
| 3300722 | R92120020 | 500 | 315 | 0.73 | 14,70 |
| 3300723 | R92120032 | 800 | 350 | 1.1 | 17,30 |

R9000 0006
IMPACT TOOL KIT
 6 pieces

€23,77
 + VAT



- > Tempered striking ends
- > Made from chrome-vanadium steel



| Code | No. | Contents | Length mm | Width mm | Height mm | Pieces | Weight kg |
|---------|-----------|---|-----------|----------|-----------|--------|-----------|
| 3300826 | R90000006 | Flat cold chisel - 125 150 mm Cross-cut chisel - 125 mm, Drift punch - Ø 3 mm Centre punch - Ø 4 mm, Pin punch - Ø 4 mm | 170 | 110 | 30 | 6 | 0.76 |

R9020 0006
PIN PUNCH SET
 6 pieces

€23,77
 + VAT



- > Acc. to DIN 6450
- > Tempered striking ends
- > Made from chrome-vanadium steel



| Code | No. | Contents | Length mm | Width mm | Height mm | Pieces | Weight kg |
|---------|-----------|----------------------------------|-----------|----------|-----------|--------|-----------|
| 3300823 | R90200006 | Splinter driver Ø 3 4 5 6 7 8 mm | 170 | 115 | 30 | 6 | 0.8 |

R2815 4010
WATER PUMP PLIERS
 automatic one-hand adjustment



- > Acc. to DIN 8976
- > Automatic setting mechanism for one-handed operation
- > Push-through joint, high stability
- > Lengthways-serrated grip surfaces
- > Chrome-vanadium steel



| Code | No. | Clamping reach mm | Length inch | Length mm | Weight kg |
|---------|-----------|-------------------|-------------|-----------|-----------|
| 3301172 | R28154010 | 35 | 10 | 250 | 0.374 |

R2800 2003
PLIERS SET
 3 pieces



€40,83
 + VAT

- > Induction-hardened cutting edges
- > 2-component-handles for a easy transfer of force
- > Chrome-vanadium steel



| Code | No. | Contents | Pieces | Weight kg |
|---------|-----------|--|--------|-----------|
| 3301155 | R28002003 | Combination pliers 180 mm, Side cutter 160 mm, Telephone pliers, straight 200 mm | 3 | 0.711 |

R2800 2004
PLIERS SET
 4 pieces



€37,97
 + VAT

- > Circlip pliers for external retaining rings, straight and angled, Size 2
- > Internal circlip pliers straight and angled
- > Dip-coated handle covers
- > Chrome-vanadium steel



| Code | No. | Contents | Pieces | Weight kg |
|---------|-----------|--|--------|-----------|
| 3301156 | R28002004 | External fuse tongs straight A2, External fuse tongs angled A21 Internal fuse clamp straight J2, Internal fuse tongs angled J21 | 4 | 0.68 |

THE KEY TO SUCCESS

Don't have the right wrench at hand or do you prefer pliers? The pliers wrench from GEDORE red combines various wrenches and pliers in one tool - an all-rounder for professionals and hobby users.

The GEDORE red pliers wrench R28184010 is a hybrid of wrench and pliers which makes it versatile in use. Whether screwing, bending, holding, pressing and gripping, everything is possible. Thanks to its intelligent design, it replaces two complete sets of wrenches (metric and imperial, 0-50 mm or 0-1.7/8"), as well as various pliers with a span of 0-50 mm. It can be conveniently and practically moved thanks to the sliding mechanism infinitely variable to different wrench sizes and is

also suitable as an alternative to the ratchet wrench. The smooth and parallel jaws serve to protect the surface, e.g. with chrome-plated or plastic workpieces. Its optimized pressing and clamping force with a tenfold conversion enables maximized power transmission while sparing your own effort.

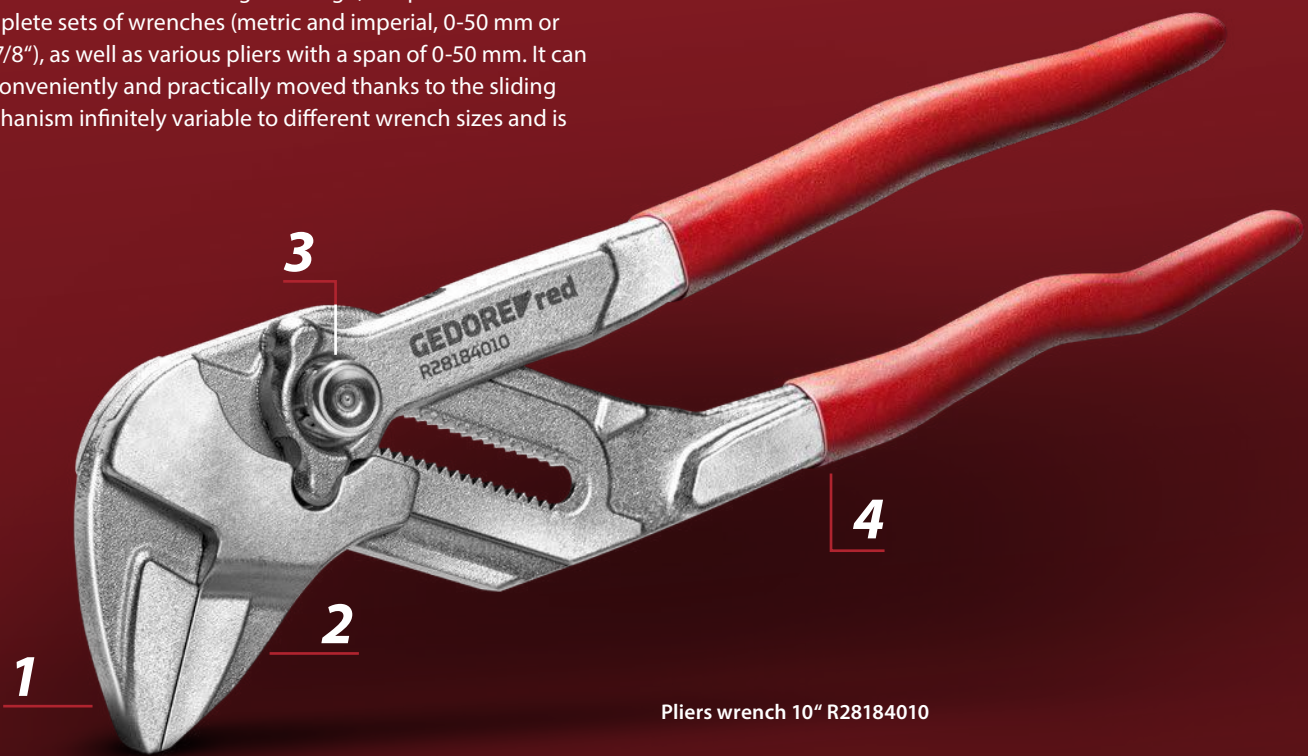

Pliers wrench 10" R28184010

1

HIGH QUALITY

- Smooth and parallel jaws protect surface-sensitive screw connections or fittings

2

HIGH POWER TRANSFER

- The high pressing and clamping force with tenfold conversion guarantees a firm hold of the workpieces

3

PRODUCTIVE AND EFFICIENT WORK

- The adjustment to the workpiece is simple and at the push of a button on the quick setting

4

DIVERSE APPLICATIONS

- The pliers wrench is suitable for screwing, bending, holding, pressing and gripping thanks to its mechanics and gripping jaws



"The pliers wrench is an all-rounder for every application and should not be missing in any tool box. The versatile use and the increased power transmission make it the perfect everyday companion."



R2818 4010
PLIER WRENCH

- › Pliers and wrench in one tool
- › Maximum capacity: 50mm or 1.7/8"
- › 17 setting positions
- › Chrome-plated surface with rough dipped handles
- › According to DIN ISO 5743



€44,61
+ VAT



| Code | No. | Clamping reach mm | Length mm | Weight kg |
|---------|-----------|-------------------|-----------|-----------|
| 3300016 | R28184010 | 50 | 260 | 0.533 |

FLEXIBLE IN USE

Whether stripping or cutting conductors, the automatic stripping pliers StrippMax – Auto deliver an optimal cutting result and are easy to hold.

The **GEDORE red wire stripper R28201165** can be used to strip all common flexible and solid conductors from 0.2-6.0 mm². Due to its low weight and the smooth-running mechanism, it ensures fatigue-free and comfortable work. The automatic scanning system adjusts itself to the cable diameter, eliminating damage to the inner conductors. In addition, the stripping pliers have an adjustable length stop of 5-12 mm with an optical length gauge on the side and easily accessible side cutters up to 2 mm Ø. The diagonal cutters allow the conductor to be cut directly without having to change tools. In order to obtain a clean cutting result in the long term, the blades can be replaced.



Wire stripper R28201165

1

PRACTICAL HELP

- With the integrated diagonal cutters, conductors up to 2 mm Ø can be cut directly without changing the tool

2

PRECISE CUTTING POWER

- By changing the blade you get a clean cutting result in the long term

3

INTUITIVE OPERATION

- The setting of the length stop is displayed directly on the optical scale and can be adjusted quickly (5-12mm)

4

PLEASANT HANDLING

- The ergonomic handle geometry and the low weight make it comfortable in the hand and ensure fatigue-free work



"Stripping and cutting conductors is easy with the StrippMax-Auto"



R2820 1165
STRIPMAX-AUTO WIRE STRIPPER

- > For all common flexible and solid conductors from 0.2 - 6.0 mm²
- > Integrated, easily accessible side cutter up to 2 mm Ø
- > Light weight
- > Pleasant handling
- > Made from glass fibre reinforced polyamide and high quality knife steel from Solingen



€18,98
 + VAT



| Code | No. | Length mm | Cable cross-section mm ² | Weight kg |
|---------|-----------|-----------|-------------------------------------|-----------|
| 3300197 | R28201165 | 165 | 0,2-6 | 0.107 |

R2910 0010
VDE WATER
PUMP PLIERS

- › For tightening and loosening screw connections e.g. control cabinets
- › Acc. to DIN ISO 8976 Form C
- › Complies with VDE 0682 Part 201 and EN/IEC 60900
- › Lengthways-serrated grip surfaces
- › With boxed joint



€23,77
 + VAT



| Code | No. | Clamping reach mm | Length mm | Weight kg |
|---------|-----------|-------------------|-----------|-----------|
| 3301413 | R29100010 | 39 | 250 | 0.393 |

R3900 2005
VDE TOOL
ASSORTMENT
 5 pieces

VDE screwdriver:

- › For slotted head screws: Acc. to DIN 5264, DIN ISO 2380
- › For cross-head screws PH: Acc. to DIN 7438, DIN ISO 8764

VDE Side cutter:

- › Acc. to DIN ISO 5749

VDE Telephone pliers, straight:

- › Acc. to DIN ISO 5745



€52,26
 + VAT



| Code | No. | Contents | Pieces | Weight kg |
|---------|-----------|--|--------|-----------|
| 3301414 | R39002005 | VDE Screwdriver slotted 3, 5.5 mm VDE Screwdriver cross-slotted PH 2 VDE Side cutter 180 mm VDE Telephone pliers 200 mm, straight pattern | 5 | 0.833 |



R9530 0017
TORCH



- > 2 levels of brightness plus warning/signal function
- > 1 W LED
- > Brightness 55-60lm
- > Light range 25-30 m

€9,49
+ VAT

| Code | No. | Length mm |
|---------|-----------|-----------|
| 3301755 | R95300017 | 130 |

Weight kg
0.156

R9570 0023
WORK LAMP



€18,98
+ VAT

- > Housing made from ABS plastic
- > Check LED battery display in 5 steps
- > Power source 3.7 v Li-ion battery, 1200 mAh
- > Incl. MICRO USB for charging

| Code | No. | Length mm | Height mm | Width mm |
|---------|-----------|-----------|-----------|----------|
| 3300002 | R95700023 | 155 | 20 | 40 |

Weight kg
0.132

LITTLE MIRACLE OF LIGHT

The light and handy penlight R95300139 is always at hand and brings light into dark corners.

The **GEDORE red pen lamp R39500139** is ideal for a wide variety of areas such as workshops, cars, basements, garages or similar. Thanks to its compact size and low weight, it is ideal as a mobile companion. The aluminum housing is well insulated and, with its IP 54 protection class, protects the inner part from the ingress of small dust particles and splash water, so the pen lamp can also be used outdoors without any problems. The lamp lasts up to 4 hours with rechargeable batteries. It can be easily secured to the wrist with the supplied hand strap, while the structured surface provides a very good grip and is therefore secure in the hand even with oily and sweaty hands. With the clip at the end, it can be easily attached to a belt, shirt or trouser pocket and is therefore always ready to hand.



Pen lamp R39500139

1

SUITABLE FOR OUTDOOR USE

- With IP 54 class protection, the pen lamp is protected against small dust particles and splash water and is therefore also suitable for outdoor use

2

MOBILE COMPANION

- Thanks to its compact size and minimal weight, the penlight is ideal for mobile use. With the clip, it can be easily attached to a belt, shirt or trouser pocket and is therefore always easy to hand

3

SECURE HOLD

- The structured aluminum housing and the hand strap ensure a secure grip and hold

**STRONG
LUMINOSITY**

"Whether in a dark basement or in a crooked corner - the 130 lumens of the small pen lamp bring a lot of light into the dark."



NEW

R9530 0139
PEN LAMP

- > Compact, slim size
- > Protected against the ingress of small dust particles and splashing water
- > Good grip even with oily and sweaty hands
- > Can also be used with gloves
- > Mobile companion for all applications
- > Practical clip for attaching to a belt, shirt pocket or trouser pocket



€17,22
+ VAT



| Code | No. | Luminous flux | Luminous duration h | Length mm | Height mm | Width mm | Weight kg |
|---------|-----------|---------------|---------------------|-----------|-----------|----------|-----------|
| 3301758 | R95300139 | 130 | up to 4 | 139 | 15 | 15 | 0.056 |

THE CONSTRUCTION SITE LIGHT

The handy LED spotlight provides light on the construction site even without a power supply and leaves no corner dark.

The **GEDORE red** rechargeable battery **spotlight R95400145** is an extremely compact work spotlight with a rubberized border and IP 64 protection class (shockproof and splash-proof) with a fold-out bracket for setting up or fastening. With its 1400 lm, it brings plenty of light to the construction site. A joint that can be rotated by 180° simplifies the alignment of the spotlight and can thus be optimally adapted to the needs. With its Li-Ion battery, the compact LED spotlight has a burn time of 6 hours and can also be used as a power bank. It is charged via the supplied micro-USB cable.

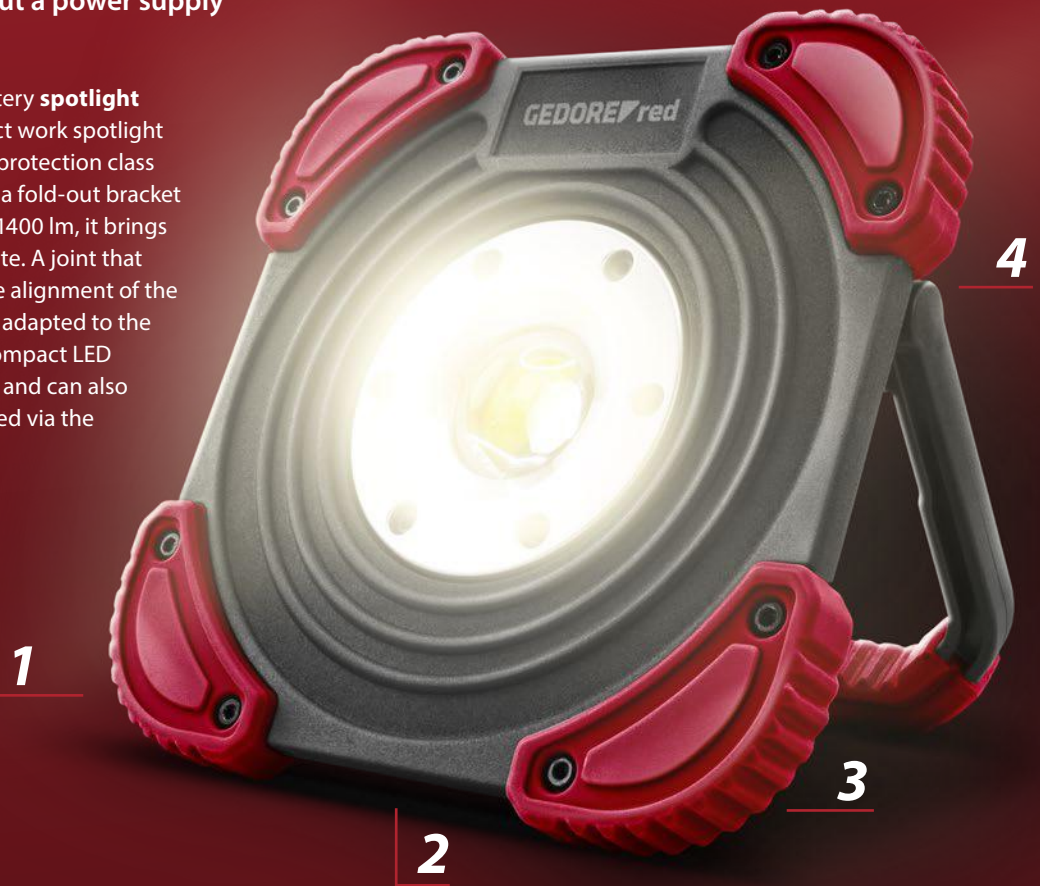

Spotlight R95400145

1

TOUGH

- Thanks to the rubberized border and water protection, it is optimally protected against dirt

2

MOBILE APPLICATION

- The integrated Li-Ion battery enables a light duration of 6 hours without a power supply

3

HANDY

- Compact portable spotlight that is easy to store away

4

FLEXIBLE ORIENTATION

- A 180° rotatable joint allows the spotlight to be easily aligned

FLEXIBLE LIGHT

"The compact and robust design of the LED spotlight makes it the perfect light source on dark and dirty construction sites. Thanks to the built-in rechargeable battery and the power bank function, you are very mobile and can quickly charge your cell phone if necessary."

R9540 0145
SPOTLIGHT

- > Compact, portable spotlight
- > Ideal for working in places without power supply
- > Shockproof and splash-proof rubberized border
- > 180° rotatable stand
- > The base is also suitable for hanging or as a carrying handle
- > Easy direction of the light
- > Power bank function for charging external devices



€29,82
+ VAT



| Code | No. | Luminous flux | Luminous duration h | Height mm | Width mm | Depth mm | Weight kg |
|---------|-----------|---------------|---------------------|-----------|----------|----------|-----------|
| 3301761 | R95400145 | 1.400 | up to 6 | 145 | 145 | 40 | 0.643 |

ALWAYS PROPERLY LIT

The inspection lamp has various folding and positioning options which make it a real all-rounder.

The **GEDORE red inspection lamp R95600320** is ideal for work that requires both hands. Thanks to the built-in magnet at the end of the handle and the 180° rotatable hook, it can be attached in different positions, which enables hands-free working. With the 5 brightness levels, the main light with its max. 500lm can be adapted to different lighting conditions. The integrated Li-Ion battery ensures a light duration of up to 12 hours and can be easily recharged via the micro USB. With an additional light in front of the head, the inspection lamp can be quickly turned into a practical flashlight by folding it in. So you are also well equipped on the go.



Inspection lamp R95600320

1

ALWAYS CORRECTLY POSITIONED

- A magnet at the end of the handle and a hook that can be rotated 180° allow for different positioning options

2

OPTIMUM ILLUMINATION

- With the 5 brightness levels of the main light, the illumination can be optimally adjusted to the lighting conditions

3

UNIVERSAL USE

- Whether as an inspection lamp or flashlight - thanks to the 2nd lamp in front of the head, the variable alignment of the lamp and the folding function, you always have the right lamp to hand

CUSTOMIZABLE ILLUMINATION

"Thanks to the many options for positioning and fixing the lamp, you have your hands free even in the darkest places."

R9560 0320
INSPECTION LAMP

- > Ideal as a work lamp for mobile use in various areas
- > 5 switching functions for adjustable brightness
- > Can be used both as an inspection lamp and as a flashlight
- > Magnet and 180° rotatable hook provide different holding options
- > Enables flexible and mobile use, as well as hands-free work
- > LED can be used both folded in and out



| Code | No. | Luminous flux | Luminous duration h | Length mm | Height mm | Width mm | Weight kg |
|---------|-----------|---------------|---------------------|-----------|-----------|----------|-----------|
| 3301760 | R95600320 | 500 | up to 12 | 320 | 43 | 33 | 0.26 |

SMALL AND FLEXIBLE

Whether attached or in the hand, the compact work lamp offers a wide range of possible uses and delivers an impressive luminosity of 300 lm.

Wherever you are, you will always find the right angle with the mounting options for the **mini work lamp R95700089** from **GEDORE red**. Attachment via magnet or clip leaves your hands free for other work. The compact work lamp has 3 setting levels: 100 lm, 300 lm and even 500 lm for a short time. The integrated Li-Ion battery provides a light duration of up to 3 hours and can be easily recharged via the micro USB. Thanks to its compact design, it takes up little space and also fits in your trouser pocket.



Mini work lamp R95700089

1

FLEXIBLE AND ADJUSTABLE

- Thanks to the clip and magnet for metal surfaces such as cars, trucks and machines, you have enough mounting options with this robust inspection light

2

POWERFUL AND COMPACT

- In everyday work, 300 lm luminosity and the very compact shape are convincing

3

MOBILE COMPANION

- Due to its compact design, it requires little space and is also ideal for use in confined spaces

**UNIVERSAL
LIGHT SOURCE**

"The mini work lamp is the ideal companion. The high luminosity and its compact and robust design clearly show their strengths here."



NEW

R9570 0089
MINI WORK LAMP



€22,60
+ VAT



- > Extremely bright lamp in a small compact format
- > Can be used in particular in confined spaces
- > Magnet provides different holding options in different work areas
- > Allows hands-free work
- > Mobile companion for all applications
- > Practical clip for attaching to a belt, shirt pocket or trouser pocket
- > Fits in any pocket



| Code | No. | Luminous flux | Luminous duration h | Height mm | Width mm | Depth mm | Weight kg |
|---------|-----------|---------------|---------------------|-----------|----------|----------|-----------|
| 3301759 | R95700089 | 300 | up to 3 | 12 | 21 | 89 | 0.035 |

R9380 0125
VICE RIGID
 fixed

- > Vice opening to the front
- > With anvil
- > Max. clamping force 25 KN



€141,18
 + VAT



| Code | No. | Jaw width mm | Usable clamping reach mm | Weight kg |
|---------|-----------|--------------|--------------------------|-----------|
| 3301737 | R93800125 | 125 | 125 | 19 |

R9380 0150
PARALLEL VICE
 swiveling

- > Vice opening to the front
- > Chuck for pipes with 13.5 - 56 mm diameter
- > With anvil
- > Max. clamping force 25 KN

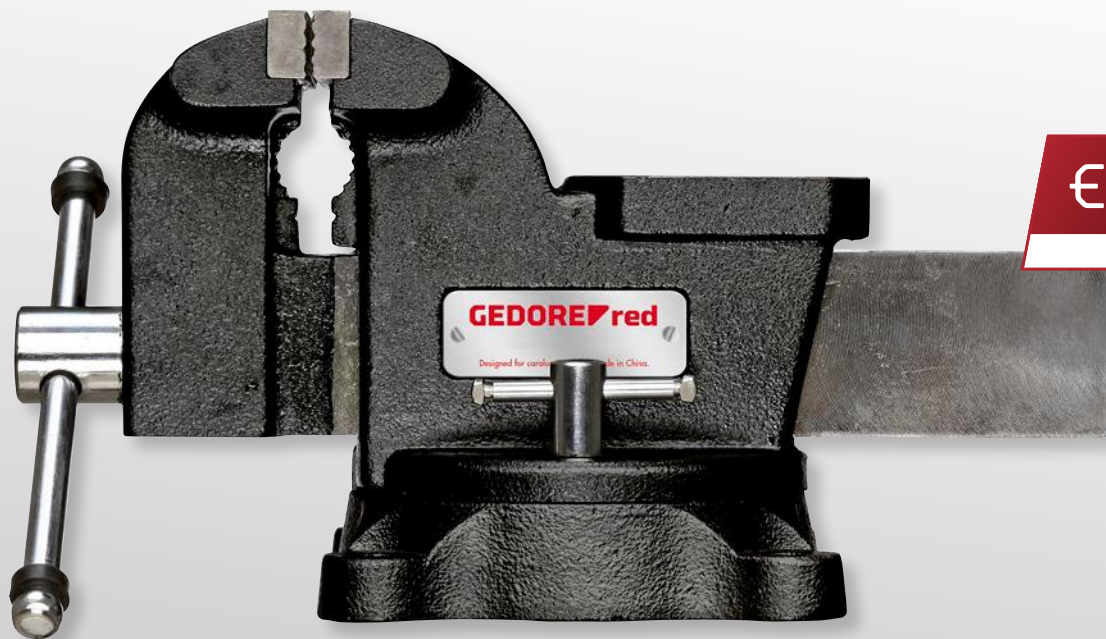

€156,30
 + VAT



| Code | No. | Jaw width mm | Usable clamping reach mm | Weight kg |
|---------|-----------|--------------|--------------------------|-----------|
| 3301738 | R93800150 | 150 | 125 | 14 |

R9410 XXXX SPIRIT LEVEL

- > Smooth square alloy profile
- > One vertical and one horizontal vial
- > Measurement accuracy: +/- 0.5 mm/m



| Code | No. | Length mm | Weight kg | excl. VAT |
|---------|-----------|-----------|-----------|-----------|
| 3301436 | R94100075 | 600 | 0.26 | 18,56 |
| 3301423 | R94100087 | 1.000 | 0.48 | 21,25 |

R9410 XXXX SPIRIT LEVEL with a movable vial, magnetic

- > Smooth square alloy profile
- > One vertical and one horizontal vial
- > Magnetic
- > Measurement accuracy: +/- 0.5 mm/m



| Code | No. | Length mm | Weight kg | excl. VAT |
|---------|-----------|-----------|-----------|-----------|
| 3301424 | R94100151 | 300 | 0.17 | 13,27 |
| 3301425 | R94100187 | 1.000 | 0.482 | 23,35 |

R9455 XXXX TAPE MEASURE

- > Housing from 2-component ABS, fitted out with metal clip
- > Automatic tape rewind and lock
- > With magnetic stop
- > Accuracy class II with MID certificate



| Code | No. | Length m | Tape width mm | Weight kg | excl. VAT |
|---------|-----------|----------|---------------|-----------|-----------|
| 3301427 | R94550003 | 3 | 19 | 0.201 | 6,29 |
| 3301428 | R94550005 | 5 | 19 | 0.265 | 9,49 |
| 3301429 | R94550008 | 8 | 25 | 0.468 | 10,83 |

R9320 0025
UTILITY KNIFE



- > With practical belt clip
- > Blade 25 mm wide
- > For right-handers
- > Supplied with 5 spare blades (125mm long, 0.5mm thick)

€10,92
+ VAT



| Code | No. | Description | Total length mm | Total width mm | Weight kg |
|---------|-----------|---------------------------------------|-----------------|----------------|-----------|
| 3301605 | R93200025 | Cutter knife, blade width 25 mm, clip | 205 | 60 | 0.28 |

R9980 0000
MULTIFUNCTION
TOOL



- > Stainless steel
- > Blade locking feature
- > Ergonomic handle, gentle power transmission

€21,92
+ VAT

| Code | No. | Weight kg |
|---------|-----------|-----------|
| 3301757 | R99800000 | 0.21 |

R9335 0051
MULTIFUNCTION SAW



- > Saw blade and bracket can be rotated 90°
- > Bracket 180° rotatable
- > Supplied with HSS bi-metal saw blade (24 tpi)
- > For metal, plastic, wood, etc.

€22,76
+ VAT



| Code | No. | Length mm | Weight kg |
|---------|-----------|-----------|-----------|
| 3301608 | R93350051 | 300 | 0.47 |

R9300 0005
FILE KIT
 5 pieces



- > 2-component-handle, for easy comfortable use
- > Made of special steel
- > In plastic bag

€28,48
 + VAT

| Code | No. | Contents | Pieces | Weight kg |
|---------|-----------|--|--------|-----------|
| 3301597 | R93000005 | Triangular file Flat file Round file Half-round file Square file | 5 | 0.82 |

R9340 0060
SCRAPER



€6,71
 + VAT

- > For minor improvements/repair
- > Apply, spread and smooth down
- > With wooden handle

| Code | No. | Blade width mm | Weight kg |
|---------|-----------|----------------|-----------|
| 3301754 | R93400060 | 60,0 | 0.1 |

R9921 0000
CARTRIDGE CAULKING GUN



€35,20
 + VAT

- > For applying silicone
- > With stable aluminium tube
- > Quick and easy cartridge change
- > Supplied with 3 tips

| Code | No. | Length mm | Height mm | Weight kg |
|---------|-----------|-----------|-----------|-----------|
| 3301753 | R99210000 | 340 | 210 | 0.84 |

The individual components at a glance

R2156 2005

R2215 0006



R2215 0013



R2215 0015



R2215 0019



R2215 0009

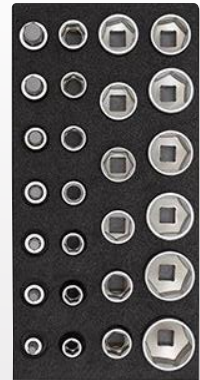

R2215 0018



R2215 0008



R2225 0000



Assortment

R21562002

No.

R22150006

Content

1/4" 2C lever reversible ratchet, fine-tooth, 72 teeth | 150 mm, 1/4" square plug-in handle 165 mm
 1/4" socket hexagon 4.4.5 5.5.6 7 8 9 10 11 12 13, 1/4" screwdriver bit socket in-hex 3 4 5 6 8 10 | 37 mm
 1/4" screwdriver bit socket slotted 5.5 6.5 | 37 mm, 1/4" screwdriver bit socket cross-slotted PH 1 2 3 | 37 mm
 1/4" screwdriver bit socket cross-head PZ 1 2 | 37 mm, 1/4" socket TX with hole T10 T15 T20 T25 T27 T30 T40 | 37 mm
 1/4" socket extension 100 mm, 1/4" sliding T-handle with slide | 115 mm, 1/4" universal joint | 32 mm

R22150013

Screwdriver slot 4 5.5 6.5 8 mm, Screwdriver cross slot PH 1 2

R22150015

Screwdriver TX T10 T15 T20 T25 T30 T40

R22150019

Engineers' hammer 300 g, Flat cold chisel 125 mm 150 mm, Cross-cut chisel 125 mm

R22150009

Centre punch 4 mm | 120 mm, Pin punch 4 mm | 120 mm, Drift punch 3 mm | 150 mm

R22150009

1/2" socket hexagon 10 11 12 13 14 15 16 17 18 19 21 22 23 24 26 27 28 30 32

R22150018

1/2" screwdriver bit socket in-hex 6 7 8 9 10 12 14 | 55 mm

R22150018

Water pump pliers 10" | 250 mm, Combination pliers 180 mm, Bent nose telephone pliers, straight 160 mm, Side cutter 160 mm

R22150008

1/2" 2C lever reversible ratchet, fine-tooth, 72 teeth | 250 mm, 1/2" socket extension 125 250 mm,

R22150008

1/2" sliding T bar with slide 250 mm, 1/2" universal joint | 66 mm

R22250000

Combination spanner 6 7 8 9 10 11 12 13 14 15 16 17 18 19 21 22 24 mm, Hexagon socket key set 1.5 2.2 5 3 4 5 6 8 10 mm

Tools for set completion



Measuring tape
3 m



Cutter Knives
with 5 spare blades
175 mm

The individual components at a glance

R2207 1005

R2235 0007



R2235 0008

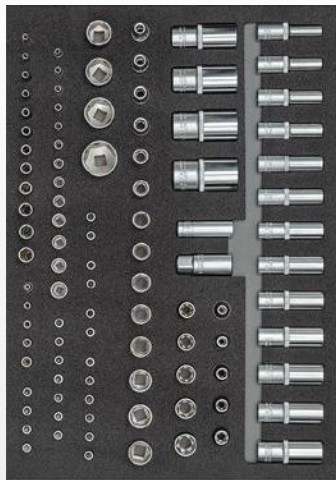

R2235 0009

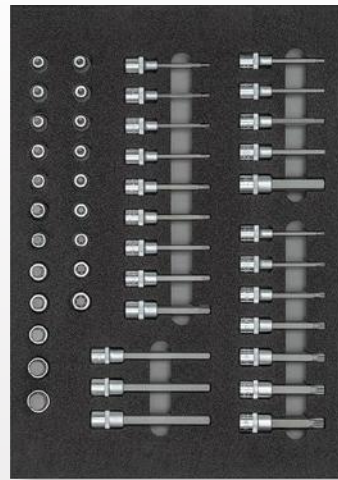

R2235 0010



R2235 0011

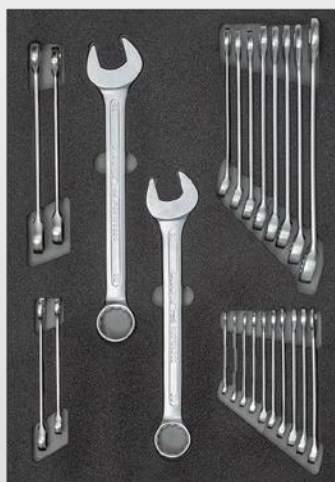

| Assortment | No. | Content |
|------------|-----------|--|
| R22071005 | R22350007 | 1/4" 2C reversible ratchet L.150mm, 1/4" socket extension L.50mm, 1/4" socket extension L.100mm 1/4" socket extension L.150mm, 1/4" cross handle w. slide L.115mm, 1/4" cardan joint L.33mm, 1/4" square socket L.62mm 2C handle, 1/4" Bit-Adapter 4 edge x 1/4 6 edge L.24.7mm, 1/4" Bit-Box SL+PH+PZ+TX+6 edge 32 pcs., 1/4" Ratchet-Screwdriver with telescopic blade, 3/8" 2C reversible ratchet L.180mm, 3/8" socket insert hexagonal 6 7 8 9 10 11 12 13 14 15 16 17 18 19 20 21 22, 3/8" socket extension L.125mm, 3/8" socket extension L.150mm, 3/8" cross handle with slide, enlarger 3/8" x 1/2" square L.44mm, reducer 3/8" to 1/4", 1/2" 2C reversible ratchet L.250mm, 1/2" universal joint L.66mm, 1/2" socket extension L.75mm, 1/2" socket extension L.125mm, 1/2" socket spanner extension L.250m, 1/2" cross handle with sliding piece, angled screwdr. Set hexagon 1.5-10mm 9 pcs. |
| | R22350008 | 1/4" Socket insert hexagonal 4 4,5 5,5 6 7 8 9 10 11 12 13 14 L.25mm, 1/4" Socket insert hexagonal 4 4,5 5,5 6 7 8 9 10 11 12 13 L.50mm, 1/4" Socket TX E5 E6 E7 E8 E10 L.25mm, 1/4" Screwdr. Insert 3 4 5 6 L.37mm, 1/4" Screwdr. Insert PH1 PH2 l. 37mm, 1/4" screwdriver Insert PZ1 PZ2 l. 37mm, 1/4" screwdriver Insert SC 5,5 6,5 l. 37mm, 1/4" screwdriver Insert TX B0 T10 T15 T20 T25 T27 T30, 1/4" screwdr. Insert TX T10 T15 T20 T25 T27 T30 T40, 1/2" Socket Insert hexagon 8 9 10 11 12 13 14 15 16 17 18 19 20 21 22 24 27 32, 1/2" Socket insert hexagonal 10 11 12 13 14 15 16 17 18 19 20 21 22 24 27 30 32, 1/2" Socket TX E8 E10 E11 E12 E14 E16 E18 E20 E22 E24, 1/2" spark plug socket 16 211 |
| | R22350009 | 1/2" screwdr. Insert 4 5 6 7 8 9 10 11 12 14 17 19 L.55mm, 1/2" Screwdr. Insert 5 6 7 8 10 12 14 17 L.100mm, 1/2" screwdr. Insert TX T20 T25 T27 T30 T40 T45 T50 T55 T60 L.55mm, 1/2" screwdr. Insert TX T20 T25 T27 T30 T40 T45 T50 T55 T60 L.100mm, 1/2" screwdr. Insert XZN M5 M6 M8 M10 M12 M14 M16 |
| | R22350010 | Combination pliers L.180mm 2C-handle, Side cutters L.160mm 2C-handle, Flat nose pliers straight L.200mm 2C-handle, 2C-Screwdriver slot 3 4 5,5 6,5, 2C-Screwdriver PH1 PH2, 2C-Screwdriver TX T10 T15 T20 T25 T30 T40, Waterpump pliers 10", Locksmith's hammer 300g L.300mm, punch 8 square 120x4mm shank d.12, centre punch 8 square 120x4mm shank d.10mm, pin punch 8 square 150x4mm shank d.10, Flat chisel flat oval 125x15x9mm, Flat chisel flat oval 150x18x11mm, Cross chisel flat oval, Pliers spanner 10" |
| | R22350011 | Combination spanner 6 7 8 9 10 11 12 13 14 15 16 17 18 19 20 21 22 24 27 30 32, Combination ratchet spanner 10 13 17 19 |

GEDORE

TOOLS FOR LIFE

GEDORE Werkzeugfabrik GmbH & Co. KG

Remscheider Straße 149
42899 Remscheid · GERMANY
Tel. + 49 (0) 21 91-596-0
Fax + 49 (0) 21 91-596-230
info@gedore.com
www.gedore.com

Vertrieb Deutschland
Tel. + 49 (0) 21 91-596-900
Fax + 49 (0) 21 91-596-999

GEDORE Automotive GmbH

Breslauer Straße 41
78166 Donaueschingen · GERMANY
Tel. +49 771 83223-0
Fax +49 771 83223-90

GEDORE Torque Solutions GmbH

Bertha-Benz-Straße 12
71665 Vaihingen/Enz · GERMANY
T +49 7042 9441-0
F +49 7042 9441-41
torque-solutions@gedore.com

GEDORE AUSTRIA GmbH

Gedore-Str. 1
8190 Birkfeld / Stmk. · AUSTRIA
Tel. +43 (0) 3174 / 363 64 00
Fax +43 (0) 3174 / 363 83 20
sales.austria@gedore.com
www.gedore.at

GEDORE Tools S.A. (Pty) Ltd.

103 Qashana Khuzwayo (Shepstone) Road,
New Germany, 3610 - South Africa
PO Box 68, New Germany, 3620
SOUTH AFRICA
Tel. +27 (0) 31 / 705 3587
Fax +27 (0) 31 / 705 32770
esales@gedore.co.za
www.gedore.co.za

GEDORE IBÉRICA S.L.

c/Arangutxi 12, Poligono Industrial de Júndiz
01015 Vitoria Alava · SPAIN
Tel. +34-945-29 22 62
Fax +34-945-29 21 99
gedore@gedore.es
www.gedore.es

GEDORE Torque Ltd

(Formerly Gedore UK)
Tannery Lane, Gosden Common
Bramley, Guildford
Surrey
GU5 0AJ · UNITED KINGDOM
Tel. +44 (0) 1756 / 70 67 00
sales@gedoreuk.com
www.gedoreuk.com

GEDORE France SARL

Parc d'activités des Béthunes - La Mare II
10, avenue du Fief - Bât. 12
BP 79144 Saint-Ouen-l'Aumône
F-95074 Cergy Pontoise Cedex · FRANCE
Tél. +33 (0)1 34 40 16 60
Fax +33 (0)1 34 40 16 61
jadore@gedore.fr
www.gedore.fr

GEDORE TECHNAG B.V.

Flemingweg 7, 2408 AV
Alphen aan den Rijn · NETHERLANDS
Tel. +31 (0) 172 / 42 73 50
Fax +31 (0) 172 / 42 73 60
info@gedore.nl
www.gedore.nl

GEDORE (INDIA) Private Limited

148, Sector 3, IMT Manesar
Gurgaon - 122051
Haryana · INDIA
Tel. +91 (0) 124 22910 - 65/66/67
Fax +91 124 2341067
sales@gedoreindia.com
www.gedore.in

GEDORE POLSKA Sp. z o.o.

ul. Żwirki i Wigury 56a
43-190 Mikołów · POLAND
Tel. +48 (0) 32 / 738-40 10
Fax +48 (0) 32 / 738-40 20
gedore@gedore.pl
www.gedore.pl

Ferramentas GEDORE do Brasil S.A.

Rua Vicentina Maria Fidélis,
275 Bairro Vicentina
São Leopoldo - RS | 93025-340 · BRAZIL
Tel. +55 51- 3589 9200
Fax + 55 51- 3589 9222
export@gedore.com.br
www.gedore.com.br

GEDORE TOOLS INC

4055 Faber Pl Dr
North Charleston SC, 29405 · USA
Phone: +1 (843) 225 5015
Fax: +1 (843) 300 0315
info@gedoretools.com
www.gedoretools.com

GEDORE Tool Trading (Shanghai) Co., Ltd.

1/F., Block 2, 1358 Pingan Road,
Minhang, Shanghai · CHINA 201109
Tel. +86-21-3388 7258
Fax +86-21-3388 7259
Service Hotline: 400 880 1858
info@gedore.cn
www.gedore.cn

Your dealer / stamp:

Brands of the GEDORE Group
gedore.com · ochsenkopf.com

IMPULSE TOOL PROMOTION valid
from 01/03/2023 until 31/12/2023.
While stocks last.

Special net prices per pc./set, plus VAT Delivery without decoration.
Technical specifications subject to modifications.No liability for printing errors.
Prices exclude VAT / for resellers only. Please ask your local dealer.

gedore.com